

WINTER GAMES

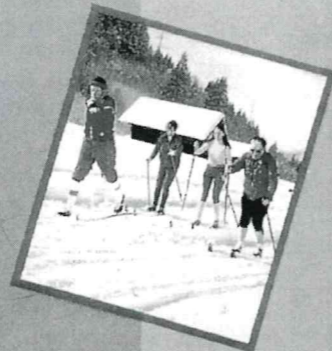

DEADLY GAMES!!

STAY ALERT
STAY ALIVE

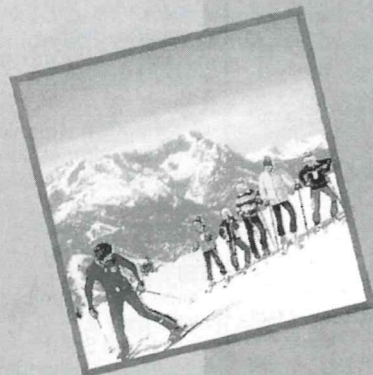
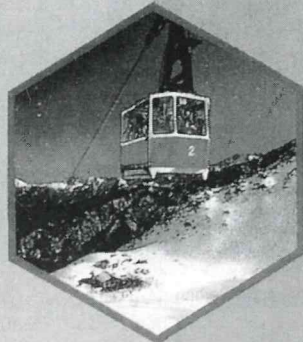

Produced by No 2 Gp PRU, based on an initial design by WO Roberts, RAF P&SS(G).

PRU U47c



No. 309 March 1997

Rheinland

42/37

EVERY KIND AND STYLE OF FURNITURE

You'll find the largest range of styles and leading European brands at
Sijben Wooncenter Roermond.

Tax-free (through Abwicklungsschein) and free home delivery!



● Romantic & Classic ● New Classics ● Trend ● Design ● Mr. Sandman ● Tweens ● Montèl

Maasnielderweg 33 - Roermond (Netherlands)

Telephone (0031) 475 - 39 28 28

Monday 1.00 p.m. - 6.00 p.m. Tuesday till Friday 9.00 a.m. - 6.00 p.m. Saturday 9.30 a.m. - 5.00 p.m.

Thursday late night shopping till 9.00 p.m.

BULLETIN

The Rheindahlen Bulletin, a monthly publication is published on behalf of the Commander Rhine Area Support Unit.

Editor:
Mrs L. Butterworth - 3284

Advertising:
Connie Coogan
02436/1072
or contact her through the
Bulletin office JHQ Mil
3284
Fax No. JHQ Mil 2106 or
Civ. 02161/472106

Typesetting:
Jane-Anne Ladd-Jones

Illustrator:
Charles Wilson

Printer:
ARS Grafische Producties &
Communicatie.
Slachthuisstraat 111,
Roermond, the Netherlands,
tel. 0031 - 475 - 317652

All advertisements must be received by the 8th for inclusion in the next Bulletin, Education Centre Annexe, BFPO 40.

Contributions must reach us by the 10th of each month, unless otherwise notified.

German address
Rheindahlen Bulletin
Bandwalk 3 JHQ
41179 Monchengladbach

Distribution
Via the GSM or 3284

All businesses are invited to advertise in the Bulletin, which has a circulation of over 3,000 copies a month. Details can be obtained from the Business Manager.

The Editor hereby declares that the publication of an advertisement in the Bulletin in no way indicates or implies sponsorship by MOD or by any Service establishments or Unit, of the advertiser or of his product or service advertised, nor will the Editor, Staff or any Service Authority become involved in any dispute arising out of any advertisement appearing in this magazine.

Furthermore, the Editor reserves the right to omit, amend or edit any advertisement or article at her sole discretion, without liability.

Front Cover

Jan Morgan designed this display with the Gardening Club at St Patrick's, for the St. Andrews Flower Festival '96.

What's Where?

Advertiser's Index	45
Bookshelf	28
Borussia	42
Careers	32
Cinema	44
Clubs	18
Community Relations	6
Cooks Companion	24
Crack Crime	30
DIY	22
Guiding	25
Health	8,16
HIVE	13
Info on Germany	26
Junior Word Search	25
Padre's Pen	29
Road Safety	6
Road Test	37
Schools Report	2
Short Story	9
Spot Light	20
Theatre	10
Video Review	40
Why not visit	21

CLUBS AND ACTIVITIES ON THE RMC

We need your help to update the list of Clubs and Activities held here on the RMC. Colonel Kirby, our new Commander, would like us to issue regular updates on the meetings held here in Rheindahlen. This we can only do with your help. If you run a club or a group of any type PLEASE, PLEASE inform us here at the Bulletin. You can ring, fax or write to us with the necessary information. Please also ensure that you keep us informed of any changes.

Telephone: 3284
Fax : 2106
Address: 3 Band Walk.

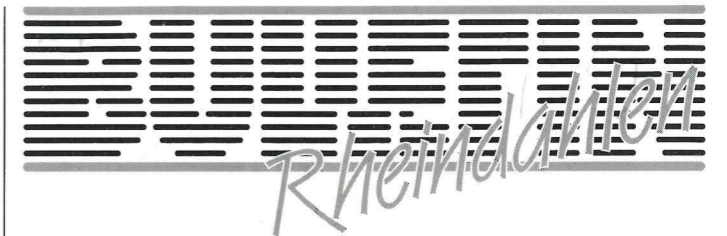

Colonel J E F Kirby OBE, Commander Rhine Area Support Unit

Colonel John Kirby was educated at Clifton College, Welbeck College and RMA Sandhurst; he was commissioned into Royal Signals on 12 December 1969.

Prior to joining the Staff College in 1981 he served as a radio troop commander in Div 1 HQ and Sig Regt, commanded an armoured troop on attachment to 2nd Royal Tank Regiment for 2 years, commanded the Corps Recruiting Team, served as an Instructor at RMA Sandhurst and was appointed as Adjutant 2 Armed Div HQ and Signal Regiment.

He attended Division 3 of the Staff College during 1981 and served in the Signals Directorate during the Falklands Operation after which he was posted, at short notice, back to RMA Sandhurst as a company commander. In June 1984 he took command of 8 Inf Bde HQ and Signal Squadron in Londonderry and was mentioned in dispatches in recognition of the work of the squadron during his two year tour. In July 1987, after a year

as a SO2 in the Directorate of Army Training, he was promoted to Lt Col and he attended the Australian Joint Service Staff College in Canberra after which he spent a year on loan service teaching at the Zimbabwe Staff College.

During 1989 he took command of 1 Armd Div HQ and Sig Regt, then based at Verden in Germany, and he deployed with the Division to the Gulf; he was appointed OBE on the Gulf honours list. In 1992 he returned to MOD as SO1 Military Home Defence in the Directorate of Military Operations during which he was selected for promotion and appointed as the Chief Instructor of the Royal School of Signals in September 1993. In March 1996 he was appointed as the first Colonel commander of the Royal School of Signals. In January 1997 he moved to Germany and took command of the Rhine Area Support Unit.

Colonel Kirby is married to Kim and they have two sons. His interests include offshore sailing, travel, computing and motorcycling. *FW

SCHOOL *report*

St George's School Bring and Buy Sale

At 15.00 hrs on Friday 17th January, the doors opened on St George's School Bring and Buy Sale for the Blue Peter Leprosy Appeal. Over 300 people supported the event, a wonderful turnout for myself and my friends who all worked so hard. We had an enjoyable afternoon, lots of lovely things to sell, a tombola and a raffle, all of which raised DM1536.87.



Lorna Aylett Year 6

Charitable readers!

Recently St Andrew's School took part in a sponsored Readathon which was held over a period of two weeks. Most of the children taking part read up to six books each and the younger infants had to colour pictures and listen to stories being read to them. Everybody in the school joined in and enjoyed it very much. Two boys, Michael Crouch and Sascha Morgan-Guy, raised DM100 each and are pictured presenting Miss Scott, who organised it all, with a cheque for £1500. This will go to the Roald Dahl Foundation and the Malcolm Sargent Cancer Fund.



Written by Ruth Howe and Hannah Law, Year 6.

Wanted

Rheindahlen Youth Football Club (RYFC) is looking for new recruits aged between 6 - 14 years old to play in its age group based teams. The club is based in JHQ Rheindahlen and competes in a local German League in properly supervised conditions. Training takes place regularly and the club will soon have its own premises.



If you are interested, ring WO2 McKenna on JHQ Mil 3006 for more details.



Holiday hockey

Over Christmas and New Year, Rheindahlen hosted four hockey coaching and training sessions to the youth of the units of the Rheindahlen military complex.



The growing popularity of "holiday hockey" has attracted large numbers of young players into the sport. Up to 50 attended each session on the all weather astroturf - until the snow and ice covered the pitch and cancelled the final session. The two age groups of nine-13 and 14-21 allowed for mixed hockey to be played by both those new to the game as well as those more skilled. The talent and enthusiasm across the age ranges was extremely high and bode well for the future of hockey as a development sport.

Several parents braved the cold to assist coaching and umpiring, while others stood at the touchlines in loyal support of their offspring. Awards were presented to

those players who showed sportsmanship and progress in skill levels. Any suggestion that holiday hockey was used as an excuse by some to get out of domestic chores or homework was unfounded!

(Another four sessions divided into the same age groups are scheduled over the Easter recess - March 27th and 29th, and April 1st and 3rd, same place and timings.)

For further information please contact Lt Col Neil Hatton on Ext 2158. *FW

OPENING HOURS PMC SHOP

Mon - Thu	10.00 - 14.00 hrs
	15.00 - 16.00 hrs
	18.30 - 19.30 hrs
Fri	10.00 - 13.00 hrs

WEEKEND CLOSED

PMC shop has a wide variety of

- * perfume
- * cd's
- * teddy bears
- * watches, jewels, etc.



PMC Shop also provides a good and inexpensive photoservice!!

Star house furnishings

For the best choices in quality furniture!!!

Now

0%

Finance available on many ranges

opposite JHQ NAAFI

Mon - Fri 10 - 6 pm
Sat 10 - 2 pm



Trenchard Road 43
41179 Mönchengladbach/JHQ
Telephone 02161 - 558234 or 556259



FROM CLASSIC TO MODERN...
We have just the furniture for you
and at excellent, 'out of town' prices.

TAX-FREE*
(free home delivery)
*If licensed to.

Come and see our selection for yourself (3 storeys full),
we're just a 30 minute drive from JHQ.

How to find us:

Take the road to Roermond. At the first set of traffic lights after the border, turn left (sign - Roerstreek, Melick). After 2 miles, just before a block of flats, turn left (sign - Roerstreek). After 1/2 mile turn left at the roundabout (Rooerstreek) we are approx 200 yards on the left.

AMPLE
CAR PARKING
SPACE



roerstreek meubelen

Keulsebaan 501, Roermond Tel: (0031)-475-324141

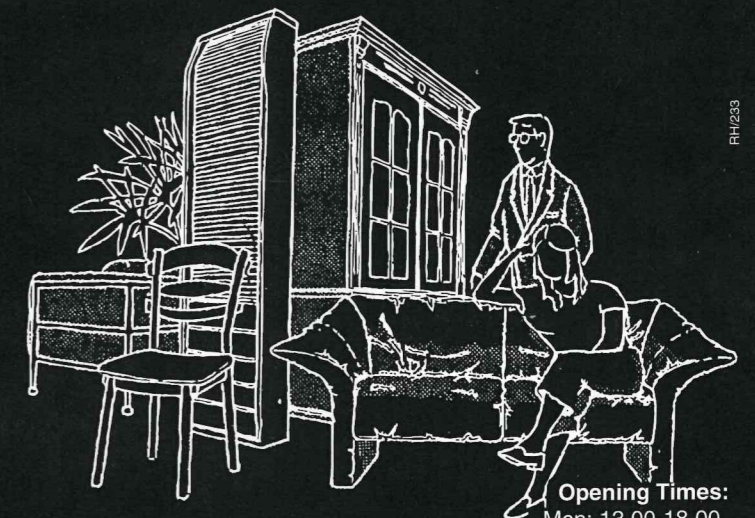

Opening Times:
Mon: 13.00-18.00
Tues-Fri: 09.30-18.00
(Thurs till 21.00)
Sat: 10.00-17.00

WILLEMS FURNITURE FREE DELIVERY

Solid oak furniture, leather suites, dining suites, wall units. We sell the 1,2,3 programme and the Hartmann Classica programme

DM2800

**T
A
X
F
R
E
E**

We offer the lowest prices

Also Second-hand furniture

1,2,3 programme



SPECIAL OFFER ON LEATHER CUSHIONED OAK SUITES

WILLEMS FURNITURE
Prinsenbaan 176
Koningsbosch

TEL.: 0031 - 475 - 302266

Open Tue to Sat from 10.00 till 18.00

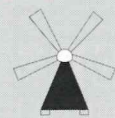

HOLLAND FURNITURE

Visit our showroom

Store hours: Mon : closed
Tues : 12am-8pm
Wed : 12am-8pm
Thurs : 12am-9pm
Fri : 12am-8pm
Sat : 10am-5pm

now open until 8 p.m. for your convenience

From PX cross railway track, get on autobahn Heerlen-Eindhoven-Antwerpen, A76. Turn right at Geleen exit. We're situated at 3rd traffic light on your right hand side. Parking in rear.

Payment programs:

- 1) 0 % financing
- 2) 16 % Financing over 3 yrs.
- 3) Layaway Program

Rijksweg Centrum 3,
6161 GA Geleen

Tel-0031-46 4742461

MERIDIAN DINING SET

Cabinet + Table + 6 Chairs
only DM 2.500,-
£ 1.245

BEDROOM SET

1. Bed complete DM 2.649,-
£ 1.249
2. Night table, 4 drawers DM 550,-
£ 274
3. 10 Drawer Dresser + Mirror DM 1.645,-
£ 816
4. Hi/Low Boy DM 1.530,-
£ 759



All furniture is offered by United Furniture, N.V. Dilsen, Bel.



Congratulations and well done! Mrs Sally Law, accompanied by her husband, takes a drink with the GOC UKSC(G), Major General Christopher Drewry following the presentation of her commendation for her good work at the St Francis Special Playgroup, Rheindahlen.

Generosity of spirit and hard work rewarded

For the past six years Mrs Sally Law has most generously given of her time as Head of Care of the St Francis Special Playgroup in Rheindahlen. Caring for some twelve children under school age with special needs during term time is a big responsibility and requires considerable ability, charm and organisational skills. Sally and her staff have demonstrated these talents in abundance and, in addition, had to make great efforts at fund raising, for St Francis is heavily dependant upon the generosity of the community it serves.

The Playgroup was founded by the initiative and drive of a group of wives in 1969 who



identified a need to make provision for pre-school aged children with special needs. It is most appropriate that Sally's hard work and great leadership in most successfully responding to the challenge of running the St Francis Playgroup for six years has been handsomely recognised in the award of a GOC's Commendation. Many Congratulations!



93 turns around JHQ

Members of RSF, Sp Coy, RASU are pictured presenting a cheque for DM4,712.80 to the St Francis Special Playgroup. Maj Richard Breeze, SSgt Jim Hamilton, LCpl Scouse

Rigby and LCpl Steve Waddington were originally planning to cycle from Calais to Rheindahlen but for security reasons this was changed to 93 times around JHQ!

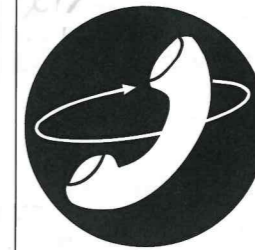

TELFORCE
COMMUNICATIONS



Presentation of Meritorious Certificates for 12 years service

Left - Herr Schmidt (JHQ - Works Council)
2nd Left - Joseph Woelterkes (Krefeld)
3rd Left - Norbert Gülpen (Krefeld)
Centre - Comd RASU
2nd Right - Herr Pungs (Ground Maintenance Officer)
Right - Mr A Mitchell (PROM)

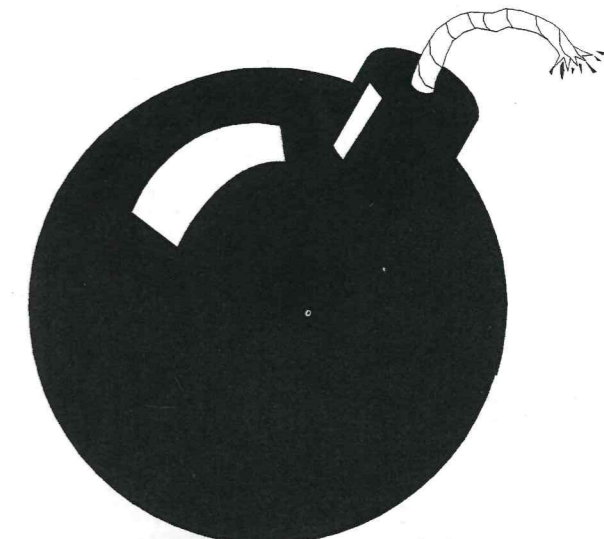

**THE TERRORIST THREAT IS ALWAYS THERE,
BE ALERT
KEEP YOUR GARAGE SECURED AT ALL TIMES.....**

ROAD SAFETY

Traffic discipline Rheindahlen Military Complex

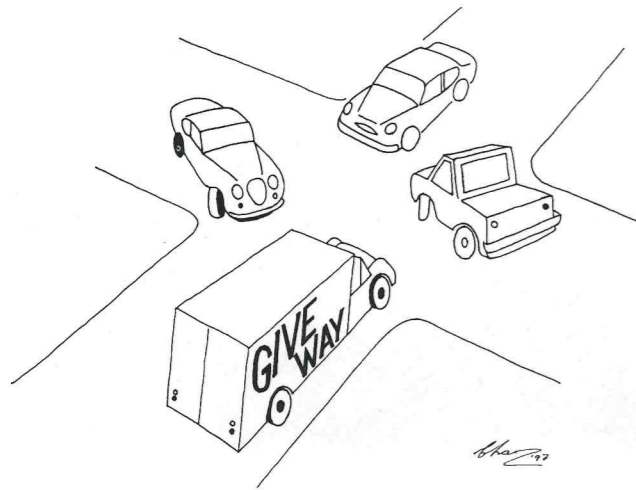

Cyclists

Cyclists must obey all traffic signs in the same way as other road users.

Ride in single file.

You must not ride on the pavement or on a footpath unless there are signs allowing shared use with pedestrians. Where there are cycle paths, you must use the cycle path on the right hand side of the road, except when a left hand side path is signed for two way use.

The paths on the RMC are one way.

Children under the age of 9 are to ride on the pavement if no cycle path is provided.

On busy roads and at night, if you want to turn left it is often safer to stop first on the right hand side of the road. Wait for a safe gap in the traffic before you start to turn.

Children under the age of 9 are not allowed to cycle across road junctions. They are to walk.

Motorists

Under German law a vehicle approaching a junction must give way to traffic moving along a main road. This includes the cycle path which forms part of the priority road. Junctions should be approached slowly, thereby showing cyclists that you are giving way.

If a collision occurs, even with a cyclist using the path in the wrong direction, the motorist is

generally held to be at fault, as the driver is required to check both ways.

When turning off a main road, drivers must take regard of the cyclists right of way if they are travelling on the road or on a cycle path in the same direction.

Right of Way.

An over-riding rule is that where a road junction or crossroads has no traffic lights or signs dictating priority, the driver coming from the right has right of way, whether it is a bicycle, horserider, horse and cart or motor vehicle. Cyclist and pedestrians are particularly at risk at junctions. Look out for them before you turn. Give them room. Remember. The RMC is designated as a built up area. Therefore the speed limit is 50KPH unless signposted otherwise.

Pedestrians

Pedestrians should use the pavements provided and not walk on the cycle path, thereby obstructing cyclists. Motorist and cyclist should exercise caution at all times.

a) Separate cycle and pedestrian paths/lane



b) Joint cycle and pedestrian path/lane



Community relations



Occupants of Married Quarters and MOD Hirings should be aware of the following German laws which apply to all military units/housing areas:

* **Washing of private cars** in other than recognised commercial car wash areas is prohibited. **Caravans** may not be parked on public roads, except when preparing for or unpacking from a journey.

* **Burning of rubbish** is not permitted at any time.

* **Washing** is not to be hung outside to dry after 14.00 hrs on Saturdays or at any time on Sundays or Public Holidays.

* **Children** are not permitted to play noisily in gardens or public places after 19.00 hrs. Some games such as football, skipping, hopscotch and roller skating are prohibited on public roads.

* Occupants are obliged to keep grass trimmed and can only use **lawn mowers** at certain times. They may

never be used on a Sunday or Public Holiday or between the hours of 12.30 - 14.30 and after 19.00 hrs any day.

* **Noises** within premises (radios etc) must be at an acceptable level between 22.00 and 07.00 hrs any day.

* **Any person in charge of a dog** on a public or private land must ensure that the dog does not endanger any persons or property. A dog must be kept on a lead in parks, and it is the responsibility of the person in charge of a dog to ensure that the dog does not soil the pavement. Dog owners must ensure that their dogs do not run loose or cause a disturbance by barking or howling. A dog known to be ferocious must be muzzled or on a leash of a maximum length of one metre and an adult must be in charge of it. Dogs should not be let loose on open country. They may be shot in certain circumstances such as if they are found on shooting land. Cats may also be shot under similar circumstances.

Marianne's Salon
(formerly Hairdresser Boehmke)

TUE - THU 9.00 - 17.30
FRI 9.00 - 18.00
SAT 8.30 - 13.00

PLEASE MAKE AN APPOINTMENT

55 05 50

We look forward to seeing you !
20, Trenchard Road

We are next to the RAF Thrift Shop, near Cassel's house

REULEN TAX FREE FURNITURE



You too can be one of the many satisfied customers who bought at Reulen Furniture

Why not come and pay our showrooms a visit. We display a large range of top class furniture in oak, walnut, mahogany and pine wood. We offer the VERY BEST PRICES around. Our aftersales service is second to none.

All furniture is delivered, assembled and serviced free of charge. 12 Month lay-away or interest-free credit schemes are available.

TAKE ADVANTAGE OF OUR SPECIAL OFFERS

now!

Opening Hours:
Mon. 13.00 - 18.00
Tues. - Fri. 9.00 - 18.00
Sat. 9.00 - 17.00
Late Night Thurs. 9.00 - 21.00

Easter
Opening
31st March
1200-1700
hours

REULEN FURNITURE
HEERENWEG 251 — HEERLEN HOLLAND
FROM HOLLAND TEL. 045 5216123 / FROM GERMANY TEL. 0031 45 5216123

DIRECTIONS:
To B.F.G. corner turn left, follow signs for Melick. Take the neutral road S15 (N 274) Roermond to Brunssum HQ Afcent, we are 1,5 km from the main entrance of HQ Afcent going to Heerlen.

Brüggen | Odiliënberg | Posterholt | Koningsbosch | Schinveld | Brunssum | H.Q.AFC | Heerlen

REULEN

Preventive Dentistry

Missing Teeth

Teeth can be missing for a variety of reasons and may have to be replaced if the gap affects appearance or makes it difficult to eat. Some teeth never form, and this can run in families. Wisdom teeth are often absent and are hardly missed. Upper lateral incisors, the ones beside the big front teeth are also a more common tooth to be missing, and these gaps usually need to be filled to create a pleasing appearance.

Front teeth are not uncommonly lost in accidents and it is important to wear a gum shield for contact sports. (If knocked out teeth are replaced in the socket straight away, there is a chance that they will survive.)

Despite enormous advances in dental treatments most teeth are missing because they have had to be extracted. Sometimes teeth are extracted because there



is no space for them, but usually it is because of severe decay which could have been repaired if the patient had seen a dentist more regularly, and need not have occurred if preventive advice had been followed. Gum disease can make teeth so loose that they all but fall out.

How can gaps be filled?

Dentures (removable plates) and bridges (an artificial tooth permanently attached to the teeth on either side of

the gap) are the main ways of restoring the space left by lost teeth. There are many different types of both to suit most situations. Implants (artificial teeth on metal pegs stuck into the gums) may become more common over the next few years.

Do gaps need to be restored?

It is healthier not to put artificial devices into mouths if possible - particularly mouths which have shown themselves to be prone to disease by needing tooth

extraction. Dentures and bridges provide extra surfaces on which bacteria can grow, and areas of stagnation where food debris and plaque can accumulate. If there are many gaps at the back of the mouth, some of these may need to be restored to save wear and tear on the front teeth and improve chewing ability.

Dental disease can be prevented by avoiding sweet food and drink between meals, and by brushing your teeth really well with fluoride toothpaste last thing at night.

Wonderful evening wear
 Come to see Jane at J.H.Q.
 Tel: 02161 551911

Also available at:
 - Detmold
 - Hohne
 - Osnabruck
 - Munster

In UK at:
 - Devizes
 - Uxbridge

General Enquiries Tel: 0044 1895 236667

CASABIANCA

STORY

The black stocking

It had been lying there for longer than it cared to think, all wrapped up tightly, neatly folded in a cellophane wrapper with barely room to survive. Then one day came the big moment, it was selected, bought, one could say released from its predicament and taken away in a condition no better than its previous one, ie unceremoniously squashed into a handbag with lipstick, comb and other utensils poking away at it all the time. The big day had to come some time. It was then carefully unwrapped, removed from the packaging and let to drop its whole length. From the top it was then very carefully folded up like a concertina in two very soft hands, from where it was allowed to expand to its fullest length over a very shapely leg, to reveal its sheen, its fineness and colour in all its glory.

Yet something was not quite right, at the top it was almost suffocated because it was being pulled by a button front and back over a half covered thigh. The heel was squashed in a shoe that was surely too narrow for any normal foot. Why complain though, the pride of being able to reveal so much sex appeal and of having hands continually feeling its softness was more than satisfactory and the relief came around every night, where it would sometimes be nonchalantly dropped on the floor, other times carefully hung over the back of a chair, be given a refreshing dunking in luke-warm water and left to breathe over a line. The next morning would then continue the same ceremony of it being slipped onto this beautiful outstretched leg and be revealed for all to see during daylight hours with a little more of the top end exposed at night. This proud feeling of being admired by thousands of eyes

every day did not last long, as one morning, the long leg sensation did not even go all the way to the top. As it was being followed up by a very fine ladder, it was suddenly and abruptly ripped off; gone was all the care and gentleness, only to be tossed in the waste bin where it was left to sulk. This peace was only disturbed for worse things to come. One cold winter morning it was grabbed in anger, taken downstairs to be ignominiously tied into the engine compartment of the car where it was whizzed round at nauseating speeds;

the top end kept meeting the foot end only to be flung apart again on the next round, it was slippery from the black grease and what an ignominy. At least it did not last long, a quick cut and the black stocking was thrown on the ground. It did not even lie there very long either, someone must still have had a fascination for a black stocking, knotted, greasy, it was tied up to hold two pieces of a broken fence, for all to see, what an end from the glorious leg days!

P Hinchliffe

Attractive Recycled Stationery

fine things made of wood

wooden jewellery
 wooden toys
 nice and interesting things for playing and reading

ars lignum

beecker strasse 36 • rheindahlen pedestrian zone • 0 21 61/58 28 64
 abwicklungsscheine are accepted

WE ARE ABLE TO SHOW YOU A LARGE SELECTION OF FURNITURE!

Tax Free
 Free Home Delivery

ERWIL

Maasnielderweg 15, Maasniel-Roermond
 Tel: 0031-475-311238

Monday 1.30 p.m. - 6.00 p.m.
 Tuesday till Friday 9.00 a.m. - 6.00 p.m.
 Saturday 9.30 a.m. - 5.00 p.m.
 Thursday evening till 9.00 p.m.

Directions: Take the road to Roermond. At the first set of traffic lights (BFG corner) go straight on, follow this road (Elmptweg) to the next set of traffic lights, once again go straight on Erwil is the second shop on the right hand side.

"De oude Spinde"
 "COTTAGE DEALER"
Solid Pine Furniture...

YOU PAY US THE TAX FREE PRICE

FREE DELIVERY

THE BIGGEST collection from Limburg

- * new and antique pine furniture
- * brass lamps
- * mirrors
- * clocks

OPENING TIMES:
 Monday closed
 Tues-Fri: 9.00 - 18.00
 Thurs: 9.00 - 21.00
 Sat: 9.00 - 17.00

MARKET
 SWALMERSTRAAT
 CAR PARK
 GODSWEEDERSINGEL
 VENLOSE
 WEG

OUDE SPINDE

Wilhelminaplein 21, 6041 CE Roermond, Telephone 0031-475-335008 You can park at the Wilhelminaplein (car park)

THEATRE

Santa in Space

Rheindahlen CATS Pantomime

Pantomime is fun, but mounting a pantomime is a very serious business. Take Rheindahlen CATS as an example. Finding a good script (months in advance) is the least of your problems. Manpower and logistic requirements are daunting: a large cast to be found, then rehearsed and, at length squeezed into scanty dressing-room space; half a dozen or more sets to be contrived for the necessary scene changes; imaginative unconventional costumes to be run up or somehow acquired. Then comes the tough decision of when best to put the show on - choose December and all your volunteer performers and helpers will complain of having no time to get ready for Christmas, select January and you are faced with a paralysing gap in your rehearsal schedule over the holiday period and are likely to be hit by the worst of the winter weather.

The production team of "Santa in Space", led by the Producer, Thelma Potts and Co-Directors Jennie Danby and Judith Rossiter, gamely rose to all challenges and succeeded in offering their audiences one of the best pantomimes seen in Rheindahlen's Little Theatre. In return, the public loyally bought out all the seats, and even the foggiest night of the New Year deterred only a few ticket-holders from rolling up to enjoy the hearty fun.

Paul Reake's script was a clever blend of the modern and the traditional to suit all tastes, local allusions being added as is usual. The plot: Vileun the Vile of Planet Varbos is determined to become Master of the Universe. Only Planet Earth remains to be conquered. Intelligence from Astra his Astrologer suggests that the best way to subject the Earthlings to his will is to deprive their children of all

toys, and so he orders his henchmen, the aptly named Null and Void, to kidnap a certain Santa Claus. Rather surprisingly, Santa is taking a little R&R incognito in a previously undetected extension of JHQ Rheindahlen called Merryvale, full of jolly villagers. He is snatched and spirited away by spaceship to Varbos. Rescue is predictably at hand, however, in the form of a task force (slow reaction rather than rapid) led by a Pantomime Dame, a Principal Boy and a multi-talented Female Robot. Along the way, a spell is lifted from a Monster (Gavin Graham) to turn him back into a Handsome Prince (Liz Taylor) in time for a romantic finale. The Monster occasioned one of the best puns of the evening. Dame Dangle, perceiving his hairy paw gripping her shoulder, quipped "I'm having a close encounter of the *furred* kind!" Had more of the jokes come up to this standard rather than falling back on innuendo, the old fogey in me would have been better pleased. That said, I found more to praise than criticize. The singalong ditty was uninspired and not catchy enough to be memorable but was compensated by the excellent notion of getting the audience on their feet to join in La Macarena.

Good use was made of the stage depth. The village sets were attractively colourful and contrasted nicely with the futuristic decor of the space-fiction scenes and the atmospheric Wilderlands backdrop. Credits here to Stage Manager, Lesley Ogle and her team, with the equally experienced Pete Ashby in support for the technical aspects of light and sound. Incidental music was almost wholly live, with Musical Director Jon Kille exploiting to good effect the weirder sonorities of the electronic keyboard. Lynsay Kille devised some pleasant choreography with April Tomlinson adding her own delightful Dancing Doll solo number.

Careful attention had been given to costumes right through the range from the tiniest chorus member to the fanciful outfits of the extraterrestrials and, particularly, Roberta the Robot with her flashing headgear and tea-strainer ear-pendants. Fantasy make-up was also effectively used, and there must have been some hectic quick-changes of face as well as costume going on backstage for the Varborites. The performers, admirably well cast, all gave convincing characterisations. I wish I could reprint the whole cast-list as a Roll of Honour. Well done, everyone! Clive Temple (Vileun the Vile) took us straight into the opening scene forcefully and proved a four-dimensional villain. Margaret Hills gave an intense Astra. Christine

Edwards' Null was eager to do well but hampered by the dull witted Void to whom Jonathan Redding nonetheless lent a dry humour. Richard Greathead was suitably rubicund and avuncular as Santa, and Helen Hinton, his assistant Crystal, was as charming as she was elegant. Captain Dick Daring was played with easy poise and a winning smile by Debbie Roche. It was a pleasure to see John Edwards back in women's clothing again (if he will permit my saying so) as Dame Dangle. His ample experience in Dame roles allows him to establish such a rapport with his audience and so control his timing that it is impossible to tell where script ends and ad lib begins.

Special mentions:

For all the children, including Elin Rossiter who was Little Tommy Tucker on the night of my visit, and Kimberley Boulton who applied her vocal cords with uninhibited gusto when lamenting her broken doll. That's what Directors mean by projection! For Ludwig Losberg (the regular familiar presence behind the Sweets counter), underrated in the programme as 'Carpenter'. The hot chestnut stand and Santa's fine sleigh were designed as well as built by him. And finally, for Amy Walker who played Roberta the Robot with great aplomb, having taken on the part at short notice which is very hard indeed to believe.

Albert Riley

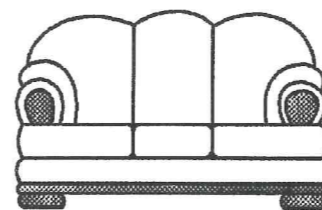

The Suite Shop

Vorster Str. 523
41169 Mönchengladbach-Hardt
☎ 02161/55 61 28

Visit our English Collection Studio

NOW ON SHOW

English Suites from only 1998.00 Tax Free

- * Superb New Styles - Fabrics
- * Oak - Mahogany Schrank
- * Solid Pine Bedroom / Diningrooms / Lounge
- * Leather Suites incl. Chesterfields
- * Top Quality Reproduction Furniture in Mahogany and Yew
- * Easy Credit Terms - Free Delivery in B.F.G.
- * Surely the Finest Collection of English Suites in B.F.G.

situated in Hardt opposite the Volksbank just 5 mins from JHQ

Hours of Opening

Mon to Fri 11.30 - 18.30
Sat 09.00 - 14.00

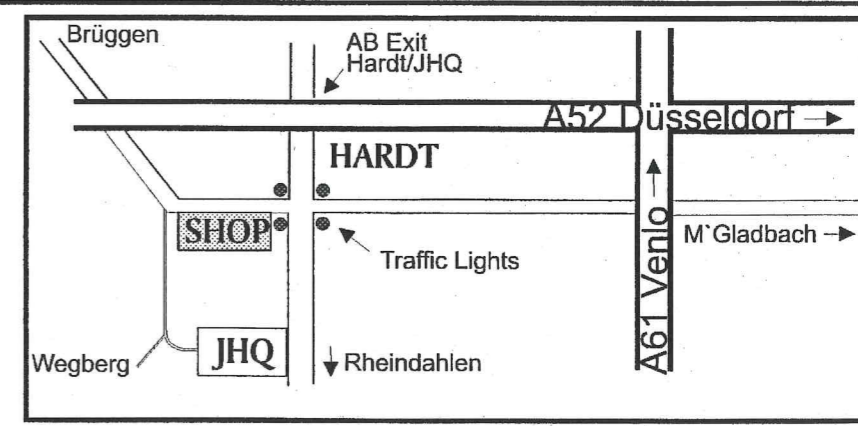

OAK FURNITURE PINE FURNITURE MODERN FURNITURE BEDROOM FURNITURE CHILDRENS BEDROOMS



Design the wall-unit of your dreams!

A choice, from a single attractive entertainment center, to an elaborate multiple-piece wall-unit.

Quality and reasonable prices, just what you want...

3+2
Dm. 2.775,-
(tax free)



OPENING HOURS:
MON. 13.00-18.00
TUES./FRI. 09.00 - 18.00
SAT. 09.00 - 17.00
LATE NIGHT THURS. 21.00

FURNITURECENTER

Den Elrew
BRONS EIKEN

DIFFERENT STYLES UNDER ONE ROOF

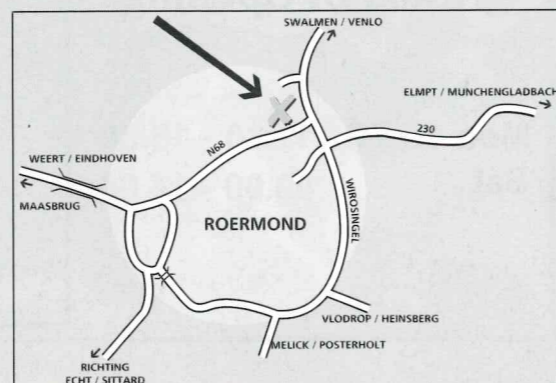

BURGHOFFWEG 30 (NEXT TO RENAULT DEALER) ▲ 6042 EX ROERMOND TEL. 0031 475 32 07 22



HIVE
information & advice

The HIVE is open:

Monday 09.00 - 15.00
Tuesday 09.00 - 15.00
Wednesday 09.00 - 14.00
Thursday 09.00 - 15.00
Friday 09.00 - 15.00

Phone: 02161 47 2519
Fax: 02161 551489

We are situated in the Church centre, Trenchard Road, opposite the BP Garage. The HIVE is normally closed on Public and privilege holidays and we would ask that you make your plans in advance, and do not disturb the Padres in the Church Office. Thank you.

RHEINDAHLEN HIVE GETS A NEW IMAGE

All the HIVES in BFG are undergoing a smart new change of image. Out go the bees and in comes a logo that tells everyone what we do! **Give advice and information!** Colonel Ian Rees, ACOS G1 determined that it would be a good investment to call in the firm of LMA, Image Consultants to create a corporate image. John Burgess, a consultant spent time in the Rheindahlen HIVE getting to know how the HIVE operates and saw the Co-ordinators

The photo shows L to R: John Burgess (Consultant LMA), Angie Keightley and Bridgette Nulty (Co-ordinators of Rheindahlen HIVE), Sue Hatton (Manager HIVE Support Team BFG), Sheila Milford (Assistant HIVE Co-ordinator) and Colin Lewis (Managing Director LMA).



Angie Keightley and Bridgette Nulty looking after their clients. He has now produced a logo that, it is hoped, will soon be seen outside every HIVE anywhere in the world. Colonel Brian Evans, the Quartermaster came up trumps and with the assistance of WO1 Shillingford and Major Jim Chadwick, OC REME Workshops, produced signboards and a very professional plaque for Lady Walker, the HIVES new president to unveil. This heralds the start of a new era in the history of the HIVES, as they continue to help their communities but now, with the new, recognisable professional image.

ARENA OBERHAUSEN

We are on the mailing list for 'Arena Oberhausen', a huge entertainment stadium located at the same site as the new 'Centre-O' shopping complex off the A42 at Oberhausen. Like Wembley Arena and the NEC, it is planned that this venue will host rock concerts, sporting events, exhibitions and family shows. A variety of international stars have been booked to perform at the Arena, including The Backstreet Boys, Walt

Disneys "World on Ice" and other major talents. For details about these and other concerts, pick up a leaflet from the HIVE.

SECURITY BICYCLE MARKING



On Wednesday 9th of April, between 3-6pm, Sgt Mark, from the RMP Crime Protection Unit, will be in the HIVE to security code your bicycle! We strongly recommend that you take advantage of this **free** opportunity to make **your** bike less attractive to the potential thief. The process takes only a few minutes, but you will need to bring the following information, in order to complete the registration documents:

For Service personnel and their dependants - **Service number**
For civilians and their dependants - **Passport number**

ROUTE PLANNERS

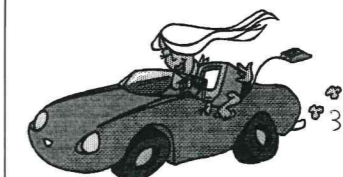

We are pleased to inform you that we now have an Autoroute Planner installed on our computer for anyone requiring directions, within Europe. The cost for this service is DM2 per destination.

WINDOW DISPLAYS

We have two large window areas available for hire if you wish to use them for display purposes. Perhaps you produce handicraft items, such as knitted woollens, dried flower arrangements, jewellery, ceramics, candles etc. For the fee of DM25 you can arrange a selection of your goods in one of our windows for a two week period. Please contact the HIVE for further details, or to make a booking for the busy period leading up to Easter.

KEUKENHOF

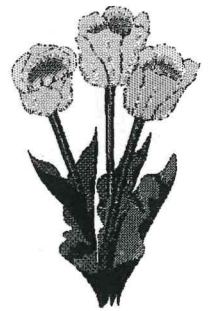

Keukenhof is a Dutch bulb park over 70 acres with 6 million tulips, narcissus, hyacinths and other flower bulbs, ancient trees, flowering shrubs, splendid ponds, fountains and many statues. It is open from March 27th through to May 22nd from 8am to 7.30pm daily. Please come and pick up a leaflet from the HIVE.

PET MICROCHIPPING

Please come in and ask us about the next date for the microchipping, as it was not available at the time this article was written.

HIVE EASTER CLOSING DATES



The HIVE will be closed from 2.00pm Wednesday 26th March and will re-open on Tuesday 1st April at 09.00am.

END OF WINTERTIME

It's official, the clocks 'spring' forward one hour at Midnight on Saturday 29th March.

ADVENTURE PARK LEAFLETS

If you are an Adventure Park freak, you will be pleased to know that the HIVE now has the leaflets available as most of the parks open towards the end of March. Please come in and ask.

Hope you all enjoy reading this month's HIVE article.

Angie and Sheila
HIVE Co-ordinators



TELFORCE
COMMUNICATIONS

VITUS VC CENTER

VISIT THE VITUS
SHOPPING CENTER
OPPOSITE THE MAIN
RAILWAY STATION
IN MÖNCHENGLADBACH.
PARKING AVAILABLE
FOR 450 CARS.
ABOUT 20 SHOPS
UNDER ONE ROOF.

SWEETS	LEATHER WEAR AND GOODS
YOUNG FASHIONS	CAMPING & TREKKING
TOYS	CONFISERIE
FASHION JEWELLERY	BAKERY
KNITWEAR	COFFEE SHOP
CONFECTIONERY	LADIES & GENTS HAIRDRESSERS
BUTCHER	SUN STUDIO
FASHION SHOPS	GIFT SHOP
TOTO-LOTTO/	CHINESE RESTAURANT
NEWSAGENT	TICKET INN (Tickets for musicals, shows and concerts)

HINDENBURGSTRASSE 170

Opened till 20.00 Saturdays till 16.00

RH/06P



Figaro-Salons

YOUR HAIRDRESSER ON CAMP

JHQ Shopping Center Marlborough - Club
Tel. 0 2161 / 55 95 68 Tel. 0 2161 / 55 04 62

Open: Tues-Fri 9.00 - 17.30 Sat 9.00 - 14.00

Body
Care
Beauty
Treatments



by
Denise Walker
Qualified
Beauty Therapist
and
Reflexologist

Both male and female clients welcome

Tuesday - Friday 1000 - 1730
Thursday 1000 - 1930
Saturday 1000 - 1400

Tel: 02161 559568

Situated in the basement of this Figaro - JHQ Shopping Centre

RH/143P

A 'Bright' new member of 'Freddies'

Georgina Bright, better known as George, has been given the task of running 'Freddies' each Thursday and Friday evening. George (20), is a trainee assistant Youth Worker and is employed to help look after young people in the Youth Club, 'Freddies', and those doing their Gold Duke of Edinburgh's Award. George lives in JHQ, went to King's School having got her 'B' Tech National Diploma in Leisure Studies. She has just come back from UK where she worked in Hyde House, a Multi Activity Centre run by the Outdoor Education Development. There she learnt rock climbing, high ropes, archery and shooting. She's enjoying working with young people and has lots of ideas to develop 'Freddies'.

George joins Iain Taylor, a Development Worker with YWCA, who was instrumental in setting up Freddies in June. Iain is hoping now to be able to pull back from his commitment to Freddies, to continue with his work with under fives and 18+ dependants who wish to return to UK, a project called Project Link. Iain has been involved with a huge variety of Youth work starting with leading Sunday Schools, Cubs, Scouts, Venture Scouts to doing voluntary work in the Student Union whilst doing a degree in Electrical engineering at South Bank University. Iain is a familiar sight to the teenagers in JHQ, and has worked hard to ensure that Freddies continues to be a great place for them to meet their pals and an alternative place to the Youth Club. Their philosophy is that kids should

Regulars at Freddies ↓



Iain Taylor and George Bright

have choice and Freddies is a very popular choice.

As Lisa Parry wrote:

Friendly Place
Radical Vibes
Excellent People
Delicious non-alco-
Drinks
Ironic Happenings
Exotic Cocktails
Sound Music

Debbie Simpson from BFBS came to interview some of the club's members and was impressed with their enthusiasm. They told her that it was a great place to go! One unnamed young heart-throb told her that it was a good 'pulling parlour'!! and lots of others agreed that it was an ace place to meet people. They like Friday's best because if there are enough members of staff they will get a Disco. However, Freddies is always in need of Volunteer members of staff to help make these things happen as there must be five responsible adults prepared to bop along to the beat of the Disco. If you have got stamina and like to dance the 'Macarina' then come along to Freddies, meet George, Iain and the gang - and have some fun!

Sue Hatton

RAM Computer Services

Trenchard Road 41 (Between Star House and English Video)
Tel: 02161 551915 Fax: 02161 557361

Computers of all specifications built to meet your requirements, including:

System Upgrades
Repairs
Reconfiguration
Software
Accessories
Multimedia Upgrades



Free Quotations

If we don't have it, we can probably get it!

RH/271

MESS DRESS

Made to Measure Mess Dress
for Officers + NCO's

The finest quality uniforms
from the specialist Military tailor

Interest Free Credit

Full Medal Service

Our representatives are in regular
attendance at most units and
will call on request

Call the specialist Military tailor on

Germany, 0171 526 1340
Ansaphone, 05751 15087
UK, +44 (0)113 282 6102



Uniformal Ltd. Meynell Avenue,
Rothwell, Yorkshire LS 26 ONU

RH/035P

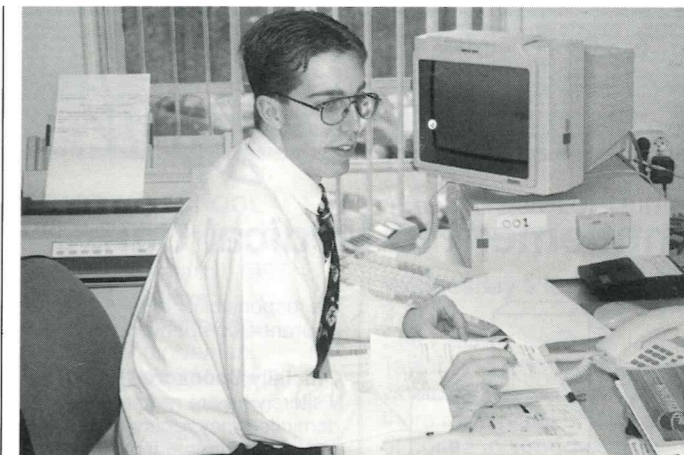

N.V.Q.s - Another option

For those of you about to leave school this summer and who think your only options are further education or employment, have you considered NVQs as an alternative?

TQG can offer you the opportunity to translate practical skills and knowledge gained in the workplace into a nationally recognised qualification. In many cases an NVQ has proven to give the edge on the job market. NVQs are centred not in the classroom but instead on work-based experience, providing training in a wide range of practical skills such as food preparation, vehicle maintenance and working with children (depending on the individual scheme). Workplaces such as kindergartens, kitchens hairdressing salons and offices are used to best provide hands-on experience whilst supplementary knowledge is gained during off the job training one day a week at your local TQG centre.

The highest standard of training is offered to all our trainees through continuous assessment by fully qualified assessors and instructors. There may also be an opportunity to gain additional qualifications such as RSA typing and St John's first aid courses.

TQG is the training organisation that provides NVQs in Germany. We currently offer NVQs in Administration, Childcare, Wholesaling, Warehousing and

Stores, Hairdressing and Catering as well as VQs in Vehicle Servicing and Dental Nursing. Each trainee receives a weekly training allowance of £29.50 if aged 16 and £35.00 if aged 17 and over. In addition, six weeks paid leave is given together with all the resources and equipment needed during the training period.

Who else can do an NVQ?

School leavers are not the only people able to benefit from a TQG training scheme as NVQs are also open to:

* Those who have finished GCSEs but have insufficient time to complete 'A' Levels before leaving Germany and may wish to fill their time in a worthwhile way whilst gaining an extra qualification.

* 'A' Level students who wish to build up valuable work experience before going to university.

* Any other dependent under the age of 25, including wives, wishing to gain an up-to-date qualification.

Pictured are TQG trainees involved in various tasks related to their individual NVQs.

For more information about these or any other NVQs please contact Janet on 02161 473274 or JHQ Mil 3274 or just call in for a chat any time at Block 3, York Drive.



Entitlement to Medical Care

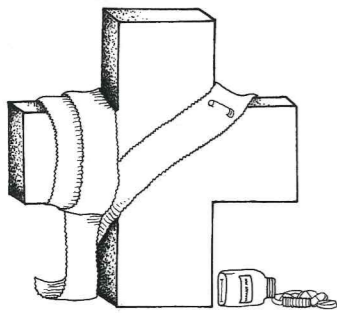

Recently, having accepted an invitation to join the Health Users Group Committee, I was rather alarmed to learn that many of us living here on the RMC do not have the necessary medical health cover for travelling outside of Germany. Not only that, some of our visitors do not have travel insurance to cover those unexpected emergencies. So, in order to redress the situation, I asked Lt Col Leach to allow me to print the following that he had previously sent to all units:

Entitled Personnel Resident in BFG

Serving and UKBC Personnel and their immediate family are entitled to the full range of Primary and Secondary healthcare at MOD expense. This includes emergency medical care within Germany, on leave in Germany, and travelling to the Channel Ports on official leave. Any bills sent to individuals should be sent to their parent medical centre for payment.

The policy on Tertiary Healthcare (treatment for complex procedures such as heart bypass surgery) is that this is to be undertaken in UK unless there are very special circumstances. Please note that it is the Health Commission's responsibility to fund THC.

NAAFI, SSVC and Members of Malcolm Club

NAAFI, SSVC and Malcolm Club members are entitled to the full range of Primary and Community Services, however addressees may be aware that NAAFI has recently taken out AOK health insurance. Personnel who require hospital care and who hold such insurance can either be referred via the Health Alliance (THA) system or directly onto the German market. Any bills raised for such referrals are

the responsibility of the insurance company, not MOD.

Officially Sponsored Visitors
Visitors who are normally UK domiciled may receive free medical treatment from Service facilities that they have been officially sponsored. Free treatment is limited to conditions or injuries that could not have been foreseen prior to the visit. Costs of emergency treatment from civilian medical facilities will not be met from Service funds. In reality this means that officially sponsored visitors are entitled to the full range of primary and community services and any remaining services at Wegberg and Rinteln. It does not include in-patient care at German hospitals, including Viersen. Visitors should be advised to have form E111 and to take out their own medical insurance for the duration of their stay as MOD will not pay any bills raised.

Others Including Non-Entitled UK Tax Payers and Most Ex-Servicemen

Other personnel who may report to a medical centre will be given immediate life saving emergency care and be offered onward referral to a hospital if required. Bills raised are not the responsibility of MOD.

Health Insurance

Many families travel extensively around Europe during their time in BFG. All are recommended to have in their possession Form E111 and to consider taking out their own travel and health insurance. Policies are available from organisations such as ADAC and NAAFI at a cost of approximately £60 per annum for the whole family. It is worth noting that Form E111 entitles the person to emergency care only. It does not cover the cost of hotel or other bills accrued, nor the cost of casualty evacuation or the repatriation of a body. If these were required, bills to many thousands of pounds can be expected.

Lt Col A J Leach
Regional Clinical Director.

So, apply for your E111 (initial forms available at the Post Office) and consider taking out a travel and health insurance.

Editor

Immunisation and vaccination for holiday travel

We have noticed that many people are leaving it until the very last moment to contact the Medical Centre for immunisation and vaccinations (Holiday Jabs) prior to travelling abroad.

Short notice often results in the would-be traveller not being able to complete the course of jabs in time, or unable to receive all necessary jabs because of the need to avoid mixing of some types of jabs.

Quite often too, jabs have to be ordered specifically for the traveller. Short notice often results in the jabs not being available from the suppliers in good time.

In order to meet the needs of all travellers, please include in your holiday plans, early jabs requirement.



Parking at the Medical Centre

Problems have arisen here due to patients/visitors double parking. On one occasion an ambulance was blocked in! Please be advised that the RMP will deal with problems arising out of thoughtless parking. Parking on the right hand side, outside the Pharmacy, is for official vehicles only (Midwives & Health Visitors). For security reasons, all cars must be registered at Reception. Please be considerate.

Call Back

Do you make international telephone calls?
Or are you using a Mobile Phone during the daytime?
If yes, then you could save plenty of money!

*
Your international rates per minute in US\$ are:
(unit of billing 6 sec./Minimum charge 30 sec.)
(1 US\$ = 1,50 DM)

→ Australia \$ -,45	→ New Zealand \$ -,55	
→ Canada \$ -,36	→ Philippines \$ 1,00	
→ France \$ -,50	→ Singapore \$ -,50	
→ India \$ -,94	→ South Africa \$ -,82	
→ USA \$ -,33	→ Saudi Arabia \$ 1,09	
→ Vietnam \$ 1,61	→ U.K. \$ -,42	
→ Thailand \$ 1,15	→ Virgin Islands \$ -,33	
→ Hong Kong \$ -,62	→ Venezuela \$ -,70	

→...220 countries more !!!

OWC charge a \$29.00 yearly customer service fee.
No minimum monthly billing charge per month per line.
Additionally you're only charged
for the calls you make using OWC

Waiting for 1998! Why? Your HotLine:
Dipl.Ing. Stefan Claßen
Phone and fax : 0 21 63 - 8 19 26
Mobile Phone 01 72 - 721 58 76

M & M GOLFSPORT

- Repairs of all types • Custom made Golf Clubs
- * Practice putting (ball return)
- * Gloves - spikes - caps - visors
- * Trolleys - practice nets
- * Bags - umbrellas
- * Putters - chippers - wedges
- * Drivers (graphite - steel)
- * Children's clubs
- * Starter sets (DM 399)

Ask for details and free expert advice.

Abwicklungsschein accepted

Am Wickrather Tor 15 • 41179 MG Rheindahlen • Tel. 58 35 00

Why wait 6-8 weeks for your Video & Television repair?

We offer you a 48 hour quick repair service on your...
Television, Videorecorder, HiFi-Equipment,
Also: All types of German bulbs, (rechargeable) batteries and (Euro-) plugs

Servicing and cleaning - our speciality

EP: Albertz

TV, Video, HiFi, Electronic-Equipment.
We do so much for you.
41169 Mönchengladbach-Hardt, Tomper Str. 13
Telephone 0 21 61/95 50 50, Fax 0 21 61/95 50 52

Electronic Partner **EP**

NOTATION

BOARDING SCHOOL OPEN DAY

Saturday 15 March 1997
10.00 - 16.00 hrs
at 34 AEC (Cambridge House), Rheindahlen
Representatives from:
State Boarding Information Service (STABIS)
Independent Schools' Information Service (ISIS)
Service Children's Education (UK)
Duke of York's Royal Military School
* Advice
* Which School? CD ROM
* Tailor made short lists
* Information
* Coffee Shop
Everyone Welcome !

'FREDDIES' VOLUNTEERS EVENING

Wednesday 5 March 7-9pm
Sue Hatton, Ian Price, Iain Taylor and George Bright would like to invite you to join them for a glass of wine/cup of coffee in 'Freddies' to discuss new ideas for the teens bar. This will include a light-hearted look at working with teenagers and how to cope with unusual situations! Ian Price, the Area Youth Worker will give us the benefit of his experience. This will help us to ensure that 'Freddies' will continue to be a great place to go for the young people in JHQ. We would be grateful if you could bring along your diaries.

EVENTS IN MÖNCHEGLADBACH

QUALITY DAYCARE

The MOD requires both childminders and day care groups established on MOD property overseas to work within the spirit of the UK legislation (Children Act 1989) and has requested the SSAFA Social Work Service to work with the provider to ensure this happens. MOD needs to be satisfied that those working with, or in the proximity of, young children are fit to undertake the task and that the premises, equipment, activities and practices are of a high standard in order to care for them appropriately and meet their needs. In 1996 the SSAFA Social Work Service established and implemented the Registration and Inspection procedures for childminders. In 1997 the SSAFA Social Work Service, in liaison with the PLA will be implementing registration and inspection procedures for all the under 8 Day Care groups (creches, kindergartens, nurseries, playgroups etc). All registered childminders and day care groups should display a SSAFA Certificate of Registration.

Further information can be obtained from your local SSAFA Social Worker.

8-16 March

An Exhibition on future projects planned for Mönchengladbach will be held near the Volksgarten. 250 exhibitors are expected and international vendors will have items for sale. Day Tickets for Adults DM8. Minors DM5.

WHITE CITY/WINDBERG RESIDENTS

Do you fancy a night out? Do you have difficulty in getting a babysitter? We may have the answer for you! The Babysitting Circle has some vacancies. Interested? Then telephone Lorraine on 890039 for more details.

AFF REPRESENTATIVE

Julia Chambers can be found in the HIVE every Wednesday from 11.30 - 13.30.

DATES TO REMEMBER

- Mothering Sunday - 9th March
- No Smoking Day - 12th March
- Clocks go forward - 29th March (Midnight)
- Easter Sunday - 30th March

CLUBS

THE RHEINDAHLEN WARGAMES CLUB (RWC)

ANNUAL CONVENTION - 19/20 APRIL

The RWC warmly welcomes you to its annual convention on the weekend 19/20 April. The convention is a combination of demonstration and participation games, trade stands and computer gaming. Like minded individuals from clubs in Germany, Holland and Belgium will show their wares by demonstrating many periods of history, Sci-fi and fantasy, especially in the popular Napoleonic and Games Workshop ranges.

In addition, this year CS Dremmen (Heinsberg) will bring along two computers for you to try out the latest computer games against other human opponents! Whilst on site they will also offer their free technical assistance for any computer or internet problems you may have.

Even if you tire of playing or watching you will be able to stroll around the international trader stands, where you can buy anything from Star Trek fleets to the most amazing multi-coloured dice! In addition there will be an opportunity for you to regenerate that old wargaming paraphernalia at our bring and buy stall. The convention will be at the Rheindahlen Rooms or the Queensway Club and will be open from 9.00 am to 5.00 pm. Refreshments are available, as is ample car parking. Please feel free to visit the convention, you will receive a friendly welcome from this multinational club.

If while reading this article you feel you what to find out more about the RWC, then please visit us on Wednesday evenings in the building attached to the Rheindahlen Bowl, or ring Maj Ron Kirkwood on JHQ Mil 5323, Mr Vic Farrer on JHQ Mil 3362 or Capt Adam Parsons on JHQ Mil 3812.

AFF REPRESENTATIVE

Julia Chambers can be found in the HIVE every Wednesday from 11.30 - 13.30.



NCT COFFEE MORNINGS

The National Childbirth Trust holds weekly coffee mornings in JHQ. They are an excellent and informal way of meeting other mothers.

If you are a mum-to-be, or a new mother who needs support, why not come along? For further information please contact: Jenny on 558263.



BRUGGEN GINGERBREAD

Bruggen Gingerbread, a Single Parents Group meets at 1900 hours (7pm) on the second Wednesday of each month. Children are welcome at the meetings. Membership is free and is open to all single parents whether they live with or apart from their children. Support members of any status are also welcome. For further information on the groups activities and details of the meeting location, contact: Gavin Graham, JHQ Mil Ext 3365 (Days) or Civil 02161 559161 (Evenings), or Karen Shooter, Bruggen Mil Ext 2304 (Days), or Leave a message on the Bruggen SSAFA answerphone: Bruggen Mil Ext 2694 and we will get back to you. Note: Soon we will have furnished accommodation available in the Bruggen/JHQ area for absent parents to use when bringing their children over for access visits. Call for details.

Rheindahlen Ladies Netball Club

Meets every Sunday at 5.30pm. All standards welcome, for more information contact Erika 02151 754121.

THE SOLDIERS' & AIRMEN'S SCRIPTURE READERS ASSOCIATION

What does it mean and who are they?

SASRA traces its roots back to 1838 and to Woolwich and the Royal Artillery.

Following the spiritual concern an NCO expressed for men in detention, a group of army officers formed the "Soldiers' Friend Society", whenever it could obtain permission of local Commanding Officers, sent into the barrack rooms specially selected and trained ex-soldiers who were themselves convinced Christians. By showing friendship, and with the power of a living message they saw men brought from darkness into light. In those far-off days such workers were called Scripture Readers because they literally read the Scriptures to men, many of whom were unable to read effectively for themselves.

The title of Scripture Reader has remained despite its strangeness to modern ears. It had to do with communication of the most important type "Faith comes by hearing and hearing by the Word of God" and that is the communication that is essential for men and women to hear. In 1938 the society was amalgamated with the Soldiers' and Airmen's Christian Association and in 1950 its present title - SASRA for short, was adopted. Scripture Readers are noted for their warm friendly approach and make vital use of every informal contact to build friendships in order to introduce others to the Lord Jesus Christ, working in barrack rooms, detention centres, on the training field and in special chaplains hours there is ample scope for a ministry that under God's guidance carries the privilege of both sowing and reaping. There is also a growing need among service families and their children and some Scripture Readers are greatly used to help in this work.

The Scripture Reader for this area is Ivor Sherwood along with his wife May. They have an open home which means any are welcome at any time, either with or without a

problem. They are here to serve you.

If you would like more information please call, or write to: Scripture Reader - Ivor Sherwood, The Church Centre, BFPO 40. Telephone: Office JHQ 3184, Tel & Fax: 02161 955899. Home: 02161 556927.



Our next meeting will take place on **Wednesday 12 March at 8pm.**

The talk will be **Collectable Wedgwood Pottery** by Dr R K Henrywood at the Dutch PMC, Chazal Road, JHQ. Entrance DM12 (Students under 23 years DM5). Doors open at 7.30pm.

The name Wedgwood is synonymous with high quality pottery. The firm achieved its status through the brilliance of the first Josiah Wedgwood in the 18th century. His researches into different materials and techniques helped to revolutionise the industry. As most of the pieces bear factory marks, it is not surprising that Wedgwood is amongst the most collected of all pottery. Dr Henrywood's lecture illustrates a wide range of wares made at the famous factory.

Everyone is welcome.



Our next meeting will be held on **6th March** in the Queensway Club from 10.00 to 14.00 hrs. There will be a cookery demonstration, lunch, a raffle and a creche will be available for those with young children, plus our usual many and varied stalls. Do come along and bring a friend. Everyone is very welcome.

BRIDGE IN THE RMC

The Rheindahlen Bridge Club meets every Tuesday evening at 1930 hrs in the Dutch PMC Club, which is situated behind the Rheindahlen Theatre.

We are an all-ranks club, affiliated to the English Bridge Union, and play duplicate bridge.

For further details ring Margaret Bunting JHQ 2393 or 550697 or just turn up with a partner any Tuesday evening.

LADIES BRIDGE CLUB

Every Wednesday 1400 hrs at ARRC Officers' Mess.

All standards welcome. We are a very friendly group.

A morning session is also possible, depending on demand.

Please join us.

Tel: Sybille Ross on 02161 551680.

SANDS: STILLBIRTH AND NEONATAL DEATH SOCIETY

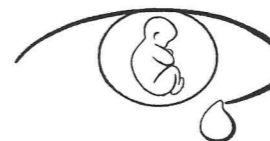

Have you suffered the loss of a baby through stillbirth or neonatal death? Would you like to know more about our support group? Do you feel you could help others in a similar situation as a result of your own personal experience?

Meetings are held on the last Tuesday of every month at 7pm in the Medical Centre, JHQ.

For more information call the Health Alliance Midwife, Angela McDermott, JHQ 472641.



TELFORCE COMMUNICATIONS



RHEINDAHLEN SADDLE CLUB

* The Rheindahlen Saddle Club provides riding facilities for adults and children aged 8 years and above. * Lessons are available every weekday evening and during the day at weekends. * It is open to all ranks of all three Services, including NATO countries, dependants and UK based civilians in the Rhine area. * Other features include: A branch of the Pony Club DIY livery Very competitive prices.

For more details contact Cpl Roy Finch on JHQ Mil Ext 2992 (Mönchengladbach Civil 02161 472992) or call in at the stables in Norwich Walk, JHQ (next to the Community Centre).

CLUBS AND ACTIVITIES ON THE RMC

We need your help to update the list of Clubs and Activities held here on the RMC.

Colonel Kirby, our new Commander, would like us to issue regular updates on the meetings held here in Rheindahlen. This we can only do with your help.

If you run a club or a group of any type PLEASE, PLEASE inform us here at the Bulletin.

You can ring, fax or write to us with the necessary information.

Please also ensure that you keep us informed of any changes.

Telephone: 3284

Fax: 2106

Address: 3 Band Walk.

China Restaurant China-Town 中國城酒樓

Credit Cards + VAT forms accepted



Parking at Bleichermühle car park



Hehler 132
(next to Bleichermühle, only 3 minutes from JHQ)
41366 Schwalmtal
Tel: 02163 - 49 724

Dine in our friendly, cosy, relaxed restaurant.

Seating for 70 people.

Free bowling Alley.

Cantonese cuisine.

Our lunchtime menu starts at DM10.

Take-away service.

Opening times
Monday - Saturday
12.00 - 15.00
17.30 - 23.30

Sundays and Holidays
12.00 - 23.30

SPOTLIGHT

Home-Start

For those new arrivals, who are not sure what Home-Start is or what it does, can I assure you that we are not part of the RAC and do not offer cookery lessons or any other domestic skills to newly weds! These are just a few of the misconceptions about Home-Start. What we do offer is a confidential, a home-based visiting scheme to families under stress for whatever reasons. We are a civilian, voluntary organisation that offers support, friendship, a listening ear and sometimes practical help to whoever needs it.

As the Home-Start organiser I am responsible for the recruitment, training and support of our volunteers and I am always available to give talks to any organisation or club, so feel free to give me a call.

Our volunteers come from all walks of life and are usually parents themselves with all the experience which brings. They undergo training in the form of a preparation course which generally consists of 10 to 12 sessions and covers such topics as the Role of the Volunteer, the Home-Start approach, communication skills and confidentiality. Outside speakers give us talks on Child Abuse, Bereavement, Alcohol Abuse and the Role of the Welfare agencies, such as the SSAFA Social Workers and SSAFA Health Visitors. We have just completed a preparation course with nine new volunteers so by the time you read this, some of them will hopefully be placed with a



family demonstrating all their new-found skills.

Without volunteers Home-Start would not be able to function, so if you feel you have something to offer, please contact me for details of our next course of preparation. Expenses are paid whilst training.

If you are feeling lonely, isolated, depressed or just feeling temporarily unable to cope, then maybe a visit from one of our volunteers would really help - they are just like a friend popping in for a coffee and a chat. All it takes is a phone call to our office and we can put you in touch with a volunteer. Alternatively, you can ask your Health visitor, social worker or medical officer to refer you.

So now you know what we do, where are we? Home-Start can be found at the Child-Care Centre on Malta Way, the office is open Monday to Friday, 09.00 - 13.00 hrs and an answerphone is available on 02161 473570 or Extn 3570. Please always feel free to leave a message and we will get straight back to you. Drop in and see us some time or come along to our coffee morning held on the first Wednesday of the month. There is also a HIVE representative present to answer any queries you may have. Look forward to seeing you there!

THE INDIA PALACE TANDOORI RESTAURANT in Mönchengladbach



Main chef from London

- Real Indian food, over 130 delicious authentic dishes to choose from
- Original Tandoori dishes
- Take away service available
- Telephone orders welcome
- Party bookings welcome
- New Menu
- Midday lunches DM 14,00

**Indian Buffet
DM 22,-
every Sunday over 25 dishes
12.00 - 22.00**

Open every day 12.00 - 14.30 / 18.00 - 23.30
except Mondays

Lupertzenderstraße 150, 41061 Mönchengladbach
Telephone 021 61 / 206405
MG - Centre opposite Rheinische Post near Deutsche Bank

RH/146p

Restaurant Poseidon Der Grieche

We look forward to your visit and to serving you in our friendly, pleasant surroundings in Wegberg's main shopping center precinct. Come and experience our traditional Greek dishes or enjoy our International menus.

*Seating for 75p.
Abwicklungsschein accepted.
Menus in English.
Ample parking at the rear.*

Opening times

Monday - Saturday 11.30 - 14.30
and 17.00 - 24.00
Sunday and holidays 11.30 - 24.00

Hauptstraße 14-20
41488 Wegberg

Telephone 02434 - 25622

RH/005p

WHY NOT VISIT

Chocolate Museum in Cologne

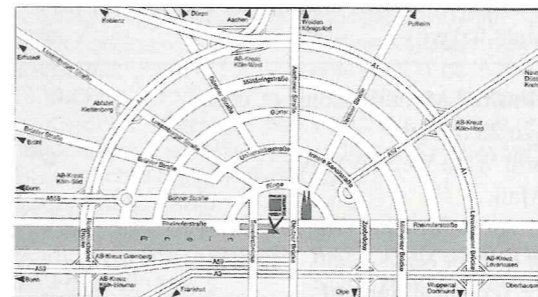

Opening Hours

Monday to Friday
10.00 to 18.00
(last entrance at 5pm)
Saturday, Sunday, PHs
11.00 to 19.00
(last entrance at 6pm)

Open on Public Holidays
except for Christmas Eve,
Christmas Day, New Year's
Eve, New Year's Day, and the
Thursday, Sunday and

Monday of Carnival time,
directly before Lent.

Entrance

Per person - DM10-
Reduced rate - DM5-
Groups (15 or more) - DM9-
Reduced rate - DM4.50-
Guided tours per group (up
to 30 people) - DM60-
with previous booking in
writing
(Booking also possible by
fax: 0221/93188860).

Winchester College Quiristers

Winchester College Quiristers will be visiting Rheindahlen Garrison March 22-23 1997.

Winchester College is the only school in Great Britain with its own ancient Choral Foundation. When the College was established in 1382 by William of Wykcham, Bishop of Winchester and twice Chancellor of England, his statutes provided for sixteen Quiristers to sing at the Chapel services. Today, over 600 years later, this inheritance flourishes. The Quiristers sing the treble part in the College's accomplished Chapel Choir, and also perform widely in their own right as a boys choir. They broadcast, record and give frequent recitals. On **Saturday 22 March** at 19.00 hrs in St Andrew's Church, the Quiristers will sing a concert.

Their programme will range from classical Lieder, through extracts from Opera to



standards by popular songwriters and arrangers such as Paul Simon, the Beach Boys and Andrew Lloyd Webber. The boys will provide their own instrumental interludes.

On **Sunday 23 March**, Palm Sunday, at 10.30hrs the Quiristers will take part in the morning service in St Boniface Church.

Don't miss this opportunity to hear the Winchester Quiristers sing !!

ORIGINAL

TEX-MEX-FOOD

EL PANCHOS



im Haus Biedemann Mexican-American Restaurant
Hauptstr. 81, 47877 Willich-Neersen
Tel./Fax 02156 - 60443

**TACOS, ENCHILADAS, TOSTADAS,
BURRITOS, CHIMICHANGAS,
FAJITAS, BUFFALO CHICKEN WINGS,
SOUTHERN FRIED CHICKEN**

Every Thursday - Barbeque Spare Ribs

Opening Times
Tuesday - Sunday 18.00 - 01.00

Book our rooms for parties from 20 - 250 people



To get to "EL PANCHOS"
Just take Autobahn 52 Krefeld to
44 Krefeld Exit NEERSEN.
At T-junction turn left and go to
the first Trafficlight, turn left. You
are now on Hauptstraße. Look
for No. 81.
This is EL PANCHOS.
Now get ready for some of the
best Mexican/American Food,
south of the border.

RH/0312p

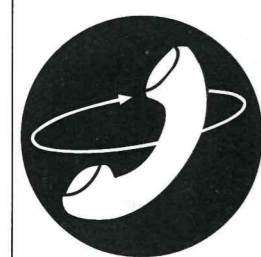

**TELFORCE
COMMUNICATIONS**

The Rheindahlen Show

Bigger than ever, the Rheindahlen Show this year promises to be the social event of the BFG calendar. To be held within the Rheindahlen Military complex over the period **1-4 May 97** it will encompass the German Bank Holiday on 1 May 1997. This year a major German Fair has been introduced to compliment the military displays and traders. Arena events will include the White Helmets Motorcycle Display Team, the RAF Falcons Parachute Display Team, the Band of the Hussars and Light Dragoons and the Pipes and Drums of the Queens Royal Hussars.

These displays will be supplemented by a programme of music from local bands, country dancing and martial arts. BFBS will be on hand to provide entertainment and broadcast live from the site. For those who yearn for a bit of excitement, the Terminator ride and the Bungee Jump will provide an interesting challenge.

Numerous commercial organisations will display their goods and the primary furniture manufacturers will all be represented. NAAFI will host the first major Car Show of the year



and there will be refreshment outlets to suit all tastes. Service and charitable organisations will provide informative displays and various cottage industry outlets will display a range of arts and crafts.

The Show has two principle aims; firstly to raise money for charitable and welfare organisations and secondly to provide an enjoyable day out for the family. With this in mind every effort has been made to ensure that the Show is a family affair offering something for everyone. The Show closes on 4 May with the drawing of the Shows Charity Draw, followed by the Beating of Retreat.

The Show is sure to provide a most enjoyable day out so make a date for your diary now, further information can be obtained from the Show co-ordination office on JHQ Ext 4765 or 4764.

A few handy hints

WIRE ME STRAIGHT

An easy way to straighten steel wire such as fencing wire is as follows. Fix one end to a solid point such as a post, and the other in the chuck of a drill. Pull the wire until it is fully stretched then switch the drill on continuing to firmly pull it. After only a few seconds the wire is straight again and will stay so. Clearly, the longer the piece of wire, the more turns required.

HANDLE YOUR ROLLER RIGHT

Most paint rollers have hollow handles. This is so that you can fix a broom handle (or something similar) to the roller to lengthen your reach, thus avoiding the need for a step ladder to paint the ceiling. In fact it is easier and quicker to paint the walls this way too. With a little practice you can now paint from floor to ceiling in one stroke. No more wrist ache and no more spotted hands or hair as you're well away from the action.

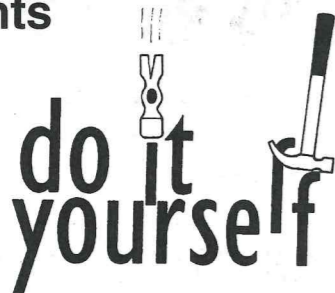

A GOOD LEAD

When using power tools in the house you are rarely more than a few metres away from a plug socket, but always just further than the cable on the tool. An extension lead of only 2m - 2.5m in length will almost always be long enough. Even if you cut a length from your normal reel you will find that you use this most of the time. A very cheap and easy way to save time and patience. Do not forget if you do need to use a long extension then always unroll the cable drum **COMPLETELY** to prevent overheating.

G I Read, PMO RAF Bruggen

Full Service Internet Account

With an account from Kleeblatt Internet Services you get a full service account available for a price that nobody can beat. We provide you with the software to connect you to our State of the Art hardware allowing you FAST and RELIABLE service. Software for Windows is included FREE of charge and installed in minutes. Our technical staff is available FREE, to help you through any problems you might have.

- Unlimited Monthly Connect Time
- Up to 28.8 kbps
- World Wide Web (WWW)
- E-Mail
- Internet Relay Chat (IRC)
- Full Usenet News Feeds
- Free Technical Support
- Online Gaming, Shopping and MORE
- Personal Web Page

all this for only
45 DM/month*
+ Set-Up Fee

Kleeblatt Internet Services,
Ludwigstrasse 14, 41061 Mönchengladbach
Tel: 02161 - 20 50 13 Fax: 18 20 22
E-Mail: clasen@koan.de, <http://www.koan.de>

RH/30BP



Optik „Alte Post“

For all your Eye Care needs - eye tests, glasses, contact lenses and advice on sight problems.

We visit the Wegberg Health Alliance Complex weekly.



Opening Times:

Tuesday - Friday
09.00 - 13.00 and
14.00 - 18.30

Saturday
09.00 - 13.00

Monday closed

Urgent appointments
always available.

Optik Alte Post

formerly *Maternus Hilger MBE / Optometrist RAF*
Bahnhofstr. (opp. Commerzbank)
41844 Wegberg
Tel. 02434 - 25666

RH/30BP

The demise of Rheindahlen's own radio programme

Restructuring, leading to a large reduction in programme staff, has brought about a number of changes to BFBS. You may have noticed that the news on BFBS One now comes from Independent Radio News rather than BFBS's own news team using BBC material. Football results have disappeared from the airwaves on a Saturday afternoon and our own local radio programme "The Rheindahlen Alternative" has ceased to exist.

Bryan Hamilton, BFBS's Station Manager in Rheindahlen, introduced the "Alternative" in the summer of 1995. Listeners will know it was broadcast every Wednesday from 12.30 - 14.00 and included a considerable range of interviews and information about life in the Monchengladbach-Bruggen areas. Music, which accounted for about half the programme time, was designed to cater for all tastes anything from the Beatles to Beethoven! "The Rheindahlen Alternative" finished towards the end of February when Bryan Hamilton, along with eleven other broadcasters, was made redundant. In its massive restructuring exercise BFBS/SSVC will be losing about 30 personnel this year as well as its considerable news reading team.

Before leaving Rheindahlen, Bryan told the Bulletin: "It has been fun presenting the "Alternative". I reckon I interviewed over 600 people in 1996 and I hope I was able to inform our listeners of matters that concerned them in an interesting and entertaining way. I was particularly pleased to have the weekly link up with Bosnia, obtaining a weekly ARRC newsletter and talking to some of those chaps from the Rheindahlen area. I think that was nice for the families. It's a shame the programme

has died and, like me, will be replaced. But a new contract with MOD has led to considerable restructuring with the emphasis on music radio rather than speech radio."

FREE BUS SERVICE FROM SOUTH WEST MQS TO MAIN NAAFI COMPLEX JHQ

If you are unable to drive, or want to leave the car at home, you may be interested (or even surprised) to know that there is a free bus service that runs Monday to Friday from the South West married quarters on JHQ up to the main NAAFI and back again.

The timetable, and pick-up points are:
09.10 Fife Drive, outside MZ Garages
09.12 Douglas Way, outside XZ Garages
09.14 Ipswich Walk, opposite Buschof Naafi
09.16 a loop around Auckland Crescent
09.18 a loop around Ottawa Avenue
09.20 Canberra Crescent
09.25 Bus stop at Main NAAFI

All above times are approximate, best to be early. The driver will pull over for you if you wave him down although they stop automatically for us regular users! Remember the driver of your bus each morning, they change from day to day, as does the colour of the bus driven. You may well get off of the only blue and cream bus at the bus-stop to find several identical ones waiting when it's time to go home. The same driver you had in the morning will be the one to take you home.

Return journey is at 11.30 and the driver will drop you off when your street is passed.

We stock everything for every pet.

Also Aquatic supplies, gardening requisites, fishing tackle.



Do you play darts?
Why not visit our special darts section.



Opening times:
Monday-Friday
08.30 - 12.30
14.30 - 18.30
Saturday
08.30 - 14.00

We accept VAT forms.
Abwicklungsschein



Hubert Adams

Inh. Kurt Wilms



Heidekamp 6 41844 Wegberg
Tel. 02434 4294 Fax 02434 25402

RH/310P

BEFORE YOU PHONE HOME PHONE US...

Interested in saving money on your phone bill?

Low cost Direct Access phone service coming to Germany soon...

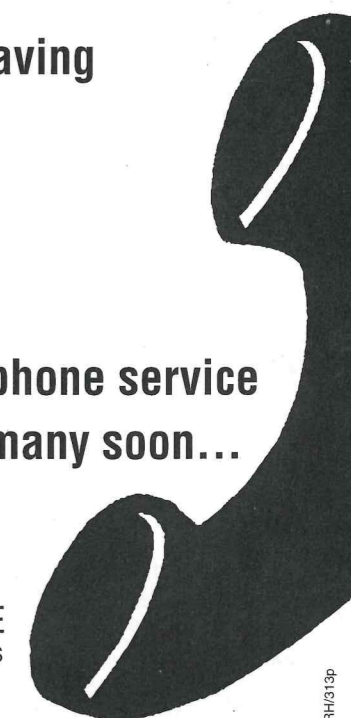

RH/310P

COMPANION

SHARK STEAK IN COCONUT MILK

600g shark steak (or other firm fish - preferably frozen)
 1 medium onion (thinly sliced)
 25g fresh ginger (peeled and grated)
 2 garlic cloves (grated)
 1 green chilli, deseeded and cut in half lengthways
 1 dry red chilli
 1 bay leaf
 6cms cinnamon stick
 1 level teaspoon turmeric
 1 heaped teaspoon cumin seeds
 1 lemon grass cut into 5cm pieces
 1 teaspoon fresh thyme
 1 teaspoon fresh parsley
 5 lime leaves
 3 tablespoons vegetable oil
 400ml can coconut milk
 Juice of half a lemon
 salt and pepper to taste

- Soak fish in water for approximately 10 minutes.
 - Remove skin from steaks and then cut them into bite size pieces and season with salt and pepper. (The fish should still be slightly frozen).
 - Heat oil in a large non-stick pan until very hot.
 - Fry fish for 4-5 minutes until brown but not fully cooked. Remove from pan.
 - Fry cumin seeds in same oil stirring constantly until brown but not burned.
 - Add onions, garlic, ginger, chilli, lime leaves, lemon grass, cinnamon stick, bay leaf, parsley, thyme and stir fry until brown.
 - Sprinkle in the turmeric and stir-fry for a few seconds.

- Return fish to the pan and gently stir fry for 30 seconds ensuring that the fish pieces remain intact.
 - Mix coconut milk with half a cup of water and add to the pan. Mix well, allow to cook on slow heat for about 10-15 minutes.
 - Add lemon juice and salt and pepper to taste.
 - Remove lime leaves, lemon grass, bay leaf and cinnamon stick from pan.
 - Serve with rice and cooking apple chutney.

[Editor's Tip: Shark steaks are available from The Exotic Spice Shop.]

COOKING APPLE CHUTNEY

3-4 cooking apples, peeled salt and black pepper powder to taste
 Water
 1 medium onion, sliced
 1 teaspoon fresh parsley
 1 spring onion, chopped
 1 tablespoon vegetable oil
 1 teaspoon wine vinegar

- Grate apples into a bowl of salted water
 - Squeeze water out of apples
 - Heat oil and fry onions until brown
 - Add apples, spring onions, parsley to pan and stir fry for about 2 minutes
 - Salt and pepper to taste
 Add vinegar and stir

Put aside until later. This dish should be served cold.

G von Dahlen

EXOTIC SPICE SHOP

Hauptstrasse 73
 41372 Niederkrüchten - Elmpt
 Tel. 02163 - 83693 Fax 02163 - 32792
 Mondays closed

We specialise in:

* Spices * Herbs * Seasonings
 * Pulses * Various Rice including Basmati * Pickles * Nuts * Papadams
 and many other items for Indian and Chinese cookery

Wholesale for Messes and Clubs
 Abwicklungsschein accepted

OPENING TIMES: Mon - Fri 08:00 - 12:00 • 13:00 - 15:00 Sat 02:00 - 12:00

AVAILABLE NOW:

- SPLIT LOGS: DM10 per wheelbarrow load DM50 per five wheelbarrow loads (with free delivery).
- BIRD SEED
- HOUSE PLANTS
- BIRD BOXES

FROM THE END OF FEBRUARY:

- PERENNIALS

See our range of Perennials all DM2 each (Delphiniums, Canterbury Bells, Pinks, Polyanthus, Aquilegia and Winter Asters).

WICKER SERVICE PROPERTY MANAGEMENT
 48 SNYDER'S ROAD, 41179 MÖNCHENGLADBACH
 TELEPHONE ENQUIRIES TO STAN FLEMING ON 02161 - 473517 OF JHQ HIL 3517

INTERNATIONALE SPEZIALITÄTEN
 »Treffpunkt verwöhnter Feinschmecker«

Inhaber Veljanovski

RESTAURANT BALKANLAND

OPEN DAILY
 from 12.00 - 14.30 hrs. and from 18.00 - 23.30 hrs.
 Club and Party-Rooms for 60 Guests
 For your Guests at home we provide a "Take-Away" Service
 Hot or Cold food Extra Menus can be arranged on request
 Parking Facilities in our own Car-Park
 Table reservations and enquiries Tel. 02161/580410

Gerkerathwinkel 62 41179 Mönchengladbach

Junior word search

Find and circle the following birds:

Blackbird	Woodpecker	Wren	Brambling
Bluetit	Nuthatch	Bullfinch	Sparrow
Robin	Dunnock	Magpie	Dove
Starling	Pigeon	Jay	Chaffinch

N	Q	B	O	W	O	R	R	A	P	S	A	D	N
U	M	K	C	O	N	N	U	D	P	H	L	R	Z
T	M	A	N	O	X	I	F	H	G	C	R	I	H
H	S	A	G	D	T	W	E	E	B	N	T	B	C
A	H	J	O	P	I	G	E	O	N	I	K	K	N
T	N	V	L	E	I	M	R	N	O	F	O	C	I
C	E	T	A	C	B	E	O	H	C	L	I	A	F
H	R	J	M	K	P	U	B	R	Q	L	G	L	F
K	W	Y	E	V	T	I	T	E	U	L	B	A	
X	S	T	A	R	L	I	N	G	Y	B	D	R	H
E	K	N	J	G	N	I	L	B	H	A	R	B	C

JHQ has a wonderful variety of birds. If you put out food you may see these and many others in your garden. Try also to spot both Great and Longtailed Tits, Greenfinches and Treecreepers.

However, once the nesting

season begins (nesting boxes available from our own Garden Centre), cease-feeding, as the baby birds can easily choke on nuts or pieces of bread. Make sure there is water available and the birds will continue to visit the garden.

Rheindahlen Brownies raising funds for Blue Peter

The girls and Guiders of 3rd and 4th Rheindahlen Brownies joined forces recently to hold a Blue Peter Bring and Buy Sale, to raise funds for LEPRA. The sale, held in the foyer of the JHQ NAAFI, raised nearly DM300. Brownies in Rheindahlen are currently going through a lean time, not due to the lack of eager young girls, but an absence of willing adult volunteers. At its peak, Rheindahlen boasted five thriving packs, but that has dwindled to three, all of which have large waiting lists of eager girls. The surviving packs face an uncertain future, due to imminent posting of their adult leaders. **Willing volunteers are desperately needed to keep these packs open. Any reader who is interested in assisting with this very rewarding task, is asked to contact Heather Farrer on 02161 - 551588).**

Remember your Guiding



If you enjoyed your Guiding and want to give a little back there are plenty of ways you can help today's Rainbows, Brownies and Guides. You can help occasionally with sports days, concerts and outings or regularly with clerical work, transport, badge testing or teaching a skill. If you have the time and enthusiasm, you can become an adult leader and run a Rainbow Unit, Brownie Pack or Guide Company.

Come back to Guiding - it's still the fun you remember.

For more information please contact the District Commissioner Heather Farrer

Chinese Speciality

The Chinese restaurant closest to you.

RESTAURANT
 皇宮大酒樓
China-Palast

FREE Delivery in JHQ for meals of 20.- DM and over

10% discount if you pick your meal up yourself

BOOK in advance for FREE BOWLING ALLEY

Abwicklungsscheine accepted
 Transport to and from JHQ

Book your table
 ☎ : 0 21 61 / 58 22 94
 Fax: 0 21 61 / 57 10 70

We are open every day from 12.00 - 15.00 and 17.00 - 23.30
 Sundays and holidays from 12.00 - 23.30

•Book our party rooms for your special function•

Buffet for 20 people or more

Chinese & Thai specialities

Hardter Str. / Koch 27
 41179 Mönchengladbach

← Hardt Rheindahlen →
 Main gate RMC China-Palast

Take the main gate out of JHQ and turn right. We are on the main road into Rheindahlen. Parking in the courtyard.

ON Germany

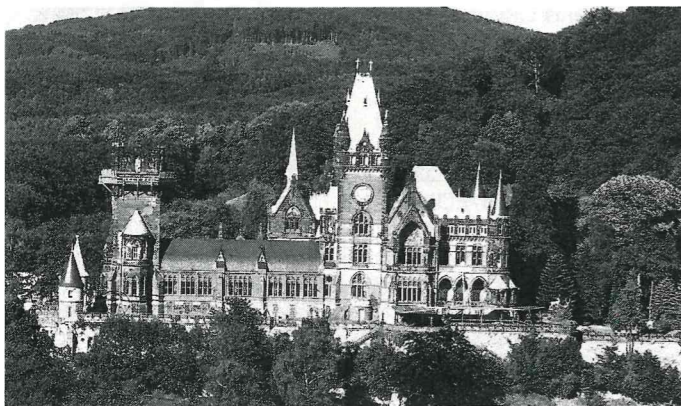

Königswinter - the Jewel on the Rhine

Königswinter is a well-known tourist centre on the Rhine and in the Siebengebirge (Seven Mountains). It is rich in tradition, beautifully situated and has a mild climate. Bustling streets, a very nice Rhine promenade and a lively traffic free zone are awaiting you in the old part of the town, and it is also only an hours drive away from Mönchengladbach. If you are searching for rest and recreation you will find them in the Siebengebirge; Germany's oldest nature reserve. Königswinter combines the Rhine valley and the mountains in an ideal manner. The name Königswinter derives from the Latin word "vintere" which means winegrowing. The Emperor Charles the Great had a domain in the slopes of the Siebengebirge. This area is the most northerly wine-growing region in Western Germany and the wine can compete with top quality wine of other districts. The symbol of the town is the Drachenfels with the ruin of its castle. You may easily reach it with Germany's oldest track railway, in a horse drawn carriage, on the back of a donkey or just by foot. From the top you have a magnificent view of a wonderful landscape and you can see Bad Honnef, Bonn, Cologne and the Eifel. Castle Drachenburg (19th century), the Nibelungen Hall and a reptile zoo invite you to come for a visit half way up to Drachenfels. The Siebengebirgsmuseum, in the old part of Königswinter, has an extensive collection

concerning history, geology, economy and culture. Regular special exhibitions are also held there. In the time of the romantic movement the Siebengebirge inspired philosophers and poets, among them Lord Byron and Heinrich Heine. It is a paradise for hikers, nature lovers and guests looking for recreation. The "seven mountains" are crisscrossed with well marked foot paths. The natural monument Weilberg near Heisterbacherrott gives information on the volcanic origin of the Siebengebirge. The Drachenfels is the most climbed mountain in Europe but the other "seven mountains" are worth climbing as well and at any time of the year. In all parts of Königswinter there are many places worth seeing; churches, chapels and wonderful half timbered houses. Other places of interest are the Chancel Ruin of the Heisterbach monastery, the Romanesque Priory Church in Oberpleis (12th century) and the guesthouse of the Federal Government on the Petersberg. If you want to have a nice change take a boat trip on the Rhine, drive with a coach through the Siebengebirge, take a walk on the riverside promenade or a sightseeing tour with the little locomobil. Königswinter also offers a lot for active holiday makers, for instance hiking, cycling, swimming, horse riding, tennis and gliding. Rhinich cheer and a gay colourful scene are awaiting



young and old when special events of the town take place each year: Rhine in flames in the Siebengebirge (3rd of May) wine blossom festival in Oberdollendorf (first or second weekend in June), a town street festival in the old part of Königswinter (last weekend in July), October festival in Thomasberg (last weekend in September), vintage festival in the old part of Königswinter (first weekend in October). The Articles I bring every month are just a small selection or what is available at the Information Room. There is much much more. Why don't you pop in and have a browse around.

Also on display at the Information Room on Germany are details of monthly current events, giving you an overview

of events happening around the Mönchengladbach area.

Information Germany
Opening hours:
Mon - Tue 0900hrs - 1500hrs
Wed 0900hrs - 1400hrs
Thu - Fri 0900hrs - 1500hrs

Information Germany is looking for volunteers to assist the Coordinator. You need to have a good working knowledge of German and basic computer skills (desirable but not essential) and not to forget a sense of humour. If you are interested please contact Ute Heward on JHQ 4482 or come and see me in the Hive, opposite the main JHQ Naafi shopping complex.

Ute Heward

Lent Lunch

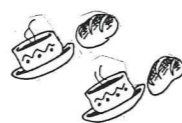

St Thomas More Church

Wednesday

(5th, 12th, 19th & 26th March)

12.45hrs



A short service followed by

Soup and rolls

at 13.00hrs

All welcome

DM5 - minimum All proceeds to Hope & Homes for Children

CHINA RESTAURANT

HONG KONG

★ FREE DELIVERY SERVICE

available SEVEN DAYS A WEEK.
to JHQ and outlying quarters.

Just ring 02434 1277 between 1730 and 2330 Hours.

★ LUNCHES

For those Midday Farewell and Celebration Lunches -
Ring us beforehand for a FAST SERVICE.

★ BUFFET SERVICE

at our restaurant for your party of 18 or more.
Price per head negotiable.

★ PARTY SERVICE

for 10 or more at your home or club.
Choose from 3 different menu options. A waiter from our
restaurant is also available to serve you.
Please ring the manager to arrange your requirements
for either service or any other **SPECIAL REQUEST.**

* Good food at reasonable prices

* Newly extended restaurant and party rooms

* Air-conditioning throughout

* Party bookings for up to 200 welcome at all
times

* New specialities on menu - over 130 dishes
to choose from

* Midday menu from DM9

Telephoned orders are welcome • Take-away food available • Large car park
Open daily from 12.00 - 15.00 and 17.30 - midnight.

Dülkener Strasse 73 - 41844 Wegberg-Rickelrath Telephone 02434 / 1277

BOOKSHELF

A selection of new books available at Rheindahlen Library

NON FICTION

Trust No-One: The X-Files

Brian Lowry

The official guide to the third season of the blockbusting TV series.

The Bonsai Workshop

Herb Gustafson

A complete guide to creating these horticultural masterpieces, from the tools needed to basic techniques.

A Lifelong Passion

A Maylunas & S Mironenko

The true story of Tsar Nicholas and his wife Alexandra, one of the most passionate and tragic couples of modern times. An intimate portrait taken from their letters and diaries.

ADULT FICTION

Vendetta: Lucky Revenge

Jackie Collins

Lucky Santangelo is back - and is facing the biggest challenge of her life. Another page-turner from one of the world's most successful authors.

The Silver Castle

Clive James

A funny and incisive novel of the Indian film world - "Bollywood" - from one of the world's favourite Australians.

The Bonny Dawn

Catherine Cookson

Set on the Northumbrian coast in the 1960s, this novel chronicles the events of just one day: a day full of promise, but with a tragic end.

1945

A Gingrich & W Forstchen

What would have happened if Hitler hadn't been defeated? An imaginative and gripping thriller from the speaker of America's House of Representatives, Newt Gingrich, and historian William Forstchen.

Elinor & Marianne

Emma Tennant

A sequel to Sense and Sensibility, continuing the story of the Dashwood sisters.

MILITARY TITLES

Who Downed the Aces in WWI? Norman Franks

Packed with facts, figures and photos on the fate of over 300 top pilots shot down over the Western Front.

Arrogance on the Battlefield

J Lee Ready

Too many generals have believed themselves invincible - only to find they're not! Ready presents a series of case studies which demonstrate how arrogance can lead directly to defeat.

Barbarossa

Alan Clark

An account of the Russian-German conflict 1941-1945 - one of the greatest clashes of arms the world has ever seen.

1745

Stuart Reid

A military history of the last Jacobite rising.



TELFORCE
COMMUNICATIONS



What's in a name?

Sunday 9th March will be Mothering Sunday. Or should that be Mothers Day? Of course it all depends upon whom you talk to or where you read about it. You might like to cast your eyes round Rheindahlen and see who uses which title.

On the one hand are the shops. They are almost completely in the Mothers Day camp. Like Valentine's Day last month, it has become one of the great merchandising festivals of the consumer society. Buying Mum flowers, a card, a present may be a good idea - it is also a splendid way to increase trade at an otherwise slack time of year.

But since Mothering Sunday is a far older name for the fourth Sunday in Lent, why bother to change the name of the day? The obvious answer is that taking Sunday away means it will not upset anyone and thus everyone can be persuaded to come and buy flowers, a card, or a present. What has also happened is that the day is not now about "mothering" but about "Mothers" and they are two very different things.

On the other hand are the churches (or at least those which have historically referred to the fourth Sunday in Lent as "Mothering Sunday"). The tradition has its roots in the English parish churches. The origins are debatable.

Some say that it comes from the words in the traditional Book of Common Prayer Gospel reading for this Sunday which describe Jesus talking of Jerusalem as like a mother hen caring for her chickens (St Luke Chapter 13 Verse 34).

Others see it in the equally old title of this Sunday as "Refreshment Sunday". This came about because it was the middle of the Lenten fast

period and a break was allowed. For those working in the big country houses this meant a holiday in which they could go home to Mum. Since their route often lay across fields where the first spring flowers were appearing, they would arrive home with a posy.

The custom is continued in our giving of flowers on this Sunday. The advantage of the continued use of the word "mothering" is that it describes a process rather than a person. It need not cause hurt to those who are not at peace with their own mothers, or who will themselves never become mothers despite a deep longing, and it does not marginalise almost half the human race who happen to be male.

So what are you going to teach your children to call this particular Sunday? As for me I will remain firm in my attempts to reclaim the title "Mothering Sunday" with all the multiple layers of experience that it describes. Here are not only our own memories of our earthly mothers, and many will want to give thanks for their love and mothering, but here is also a chance to celebrate the aspects of mothering which can at times be the expression of the love of any person for another, and, here too, is the opportunity to rejoice in the experience of a loving community which can be called "Mother Church" and which displays in our own community something of the love of God.

The issue may seem trivial to some. What, after all, is in a name? It can be a great deal when it becomes a symbol of what we believe. Those who tell me that they have rejected the Christian faith because they can not believe it are not the ones who let this Sunday pass by as another day. They are

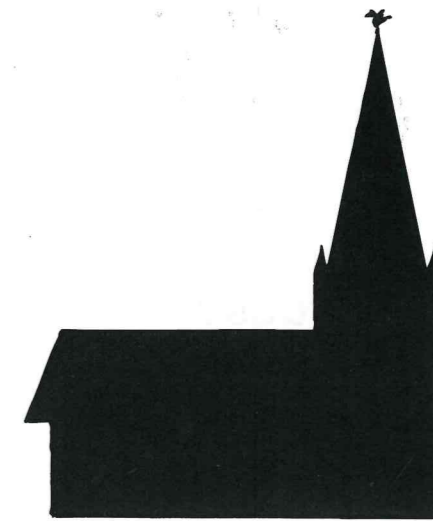

frequently the ones who instinctively think that the whole idea of a Mother's Day must be something for our society to celebrate.

This Sunday is not the high spot of the Christian year. At the end of the month we shall be commemorating the story of the final days of the life of Jesus. We shall hear again the tale of his death and ponder its meaning for us. Then we shall enjoy the

sense of wonder as the good news of his coming to life again is put into context. And if you wonder what that is all about, why not come and find out?

Padre Peter Howson
Assistant Chaplain General
HQ UKSC(G)



British TRAVEL

... at your service!

NATO FORCES AGENT:

- CHANGE DUTY WARRANTS FOR RAILTICKETS
- FERRIES TO UK, SCANDINAVIA & MEDITERRANEAN
- SPECIAL EXCURSIONS TO UK WITH BA & AIR UK
- FLIGHT OFFERS WORLDWIDE
- QUICK TRIP HOME BY LE SHUTTLE
- EURO DISNEY BOOKINGS & HOLIDAYS WORLDWIDE

Come and have a chat with our friendly, experienced staff
at 5 Oakham Way, JHQ or call us on 02161 - 55455
Mon-Fri 8.45 - 16.45



RANI

The Indian Restaurant near you!

•NEW CHEF •NEW MENU
INCLUDING **BALTI DISHES**

- Party bookings welcome
- Take-away services available
- Abwicklungsschein accepted

English spoken

Opening times:
Tues - Fri { 12.00-15.00
 { 18.00-24.00
Saturdays { 12.00-14.00
Sundays and { 18.00-24.00

Aachener Straße 48, 41812 Erkelenz Telephone 02431/4376



CRIME

TOGETHER WE'LL CRACK IT

Would you know if your child was using drugs?

Most parents are not well informed about the effects of drugs. Having reliable information will help you understand more about drugs and the dangers of taking them, although the soundness of your family relationship will be more important.

Unfortunately, in this day and age, drugs are all too readily available. In JHQ, with Holland just a few miles away, drugs are easy to get hold of. The pushers can get an endless supply with the minimum risk of getting caught. The Police and Customs will probably never be able to completely stop illegal drugs. But don't expect to see drug pushers hanging around the school giving samples to the children.

If your children wants to take drugs; it is likely they will find someone, usually a friend, who can supply them. The drugs they will try vary according to price, fashion and location.

So what can you do?

Prevention is better than cure. Help your child to develop a sensible attitude towards drugs. Explain to them why mum takes painkillers when she has a period, or why dad has to

take painkillers for his back injury. It is important that children understand why we take the drugs we do - and the difference between appropriate and inappropriate drug use. This process must start when the children are quite young, and continue throughout childhood and adolescence. If drug use is discussed in its appropriate context, it may lose some of its attraction as a secret and mysterious thing to become involved in.

Everyone will have their own reasons for trying drugs. Some of these reasons are:

- * Sociability
- * Availability
- * Boredom
- * Curiosity
- * Experiment
- * Peer Pressure

Whatever the reason, don't jump to conclusions. Talk to your child calmly and responsibly. Don't preach, listen to what they have to say. And above all, show them you care. What may have been an isolated incident could be turned into a focus for opposition if handled badly.

WARNING SIGNS

Some of the signs of drug use are just like the normal

signs of growing up. So if your child suddenly becomes moody or distant - don't immediately jump to conclusions.

* Sudden and regular change of mood

* Loss of appetite

* Gradual loss of interest in school, friends, hobbies, sports etc.

* Increasing evidence of lying and other furtive behaviour

* Loss of money or objects from the house

* Unusual stains, marks or smells on the body or clothes or around the house.

All drugs, even legal drugs, can affect your child's health. The symptoms will depend on the type of drug, the frequency with which it is used and the situation.

It can also be an expensive habit and your child may turn to crime to feed this habit. If they become hooked on drugs, what started as petty crime will soon lead to crime of a more serious nature, in turn, involving the Service Police.

It is unlikely you will find any drugs on your child; you are more likely to find some possible evidence of drug use. This may include:

- * Scorched pieces of tin foil
- * A home-made pipe
- * The remains of a hand-rolled cigarette with a cardboard tube filter.

Sometimes things get out of



hand. Parents may be unwilling or unable to tackle a drug problem at its earliest stages, they may not even know there is a problem until it is serious and they can no longer cope.

If you have a problem with your child and drugs, or you simply want to understand more about drugs, there are many counselling agencies that can help - use them before it is too late.

For more information contact your Crime Prevention Officer on JHQ Mil 2334.

All calls will be treated in the strictest confidence.

BFG CRIMELINE FREEPHONE 0130 - 842222



YOUR CONFIDENTIAL SERVICE POLICE HOTLINE
24 HOURS A DAY

RELATE BFG

- * A confidential service
- * Specialising in relationship counselling
- * Centres throughout BFG
- * Trained Personnel
- * Operating to UK standards

For appointments and information please call
Civ: 02161 472826

Restaurant CHINA GARTEN 中華園

Inh. Lai

☎ 0 24 34 - 10 69

Delivery

Our delivery service is now available

SEVEN DAYS A WEEK

Delivery to JHQ and outlying quarters.

Just ring **02434 1069** between 17.30 and 23.30 Hours.

There is **No Delivery Charge** for meals of DM 30 or over.

If the service is not up to our high standard or delivered food is cold, phone up the boss Mr Lai.

Start collecting your tokens now and get a free gift

"EAT TILL YOU DROP"

self serving buffet

including starters and desserts

Sun. midday	12.00 - 14.00 hrs
Wed. evenings	19.00 - 22.00 hrs
Fri/Sat/Sun evenings	18.00 - 22.00 hrs

Over 15 main courses to choose from

Children under 10 years	only DM 21,00
Wed. midday special	only DM 11,00
	12.00 - 14.00 hrs
	only DM 11,50

NEW WINTERGARDEN

*Friendly service,
English speaking.
Excellent food guaranteed.*

We accept Abwicklungsscheine!
Advance bookings recommended

(from HQ to
China Garten
Restaurant in
Wegberg - Beeck
about (5 km)
10 minutes
to drive)

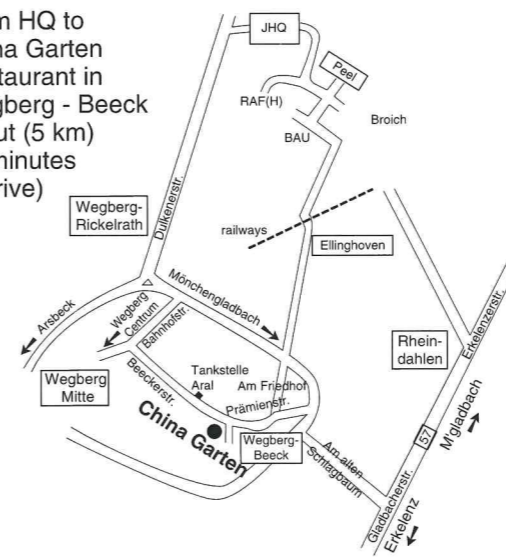

**Im Wiesengrund 2
41844 Wegberg - Beeck**

CAREERWATCH

The Rheindahlen Careers Centre has now reopened in Windsor School. No fanfares and celebrations but there will be a number of open days for the public to come and view **and** try out for themselves the resources we have which are designed to help the children of Service and Civilian Personnel understand better the next steps to take in their career decision making.

HIGHER EDUCATION - 1997 entry

Previous Careerwatch articles have described the approaches to applying for entry to university or colleges of higher education.

For people who are waiting with baited breath to get their final replies from their UCAS entries, the next stage of application now needs to be negotiated. This is to apply for an award to undertake a course of higher education.

What are awards, grants and fees

Award means the money that your LEA pays towards your living costs (**the grant**) and the college's bill for your tuition (**the fees**).

Your LEA usually pays the fees direct to your college. Note there is sometimes a limit on the amount they will pay and if this is the case your parents, unless you are a mature student, will have to pay the rest.

Your grant is means tested.

This is a test of income, to show whether you qualify for financial help from your LEA. There are standard scales for working these things out.

"Someone please tell me to which authority I should apply" has been the most common question asked of me at this time of year.

Booklets from the Department for Education and Employment, freely available from the careers centre, say that "the LEA

responsible for considering your application is usually the one in whose area you normally live" some carefully chosen words you will notice here. This is OK for someone living in the UK - not for a parent in BFG. Parents of students in BFG have to prove that they have been temporarily employed abroad and are ordinarily resident in the UK.

This is usually the piece of jigsaw that proves the most difficult to fit together.

Ordinary Residence has been defined in the courts as habitual and normal residence from choice and for a settled purpose throughout the prescribed period of 3 years prior to the commencement of the course.

The DfEE passes guidelines to LEA's for them to interpret and describe their own criteria for taking on the administrative task of processing the award application. Some authorities are more 'prickly' than others in passing judgement on military and civilian parents working abroad.

Advice on how to proceed is available from the Careers Centre by calling and describing your personal situation. We will explain the next steps for you to take. Standard letters, designed by Service Childrens Education available from the Careers Centre, will assist in our application.

Most parents end up with successful applications for higher education awards on behalf of their children.

However, it would help us considerably if we were made aware of the extent of this problem throughout Germany. We get numerous phone calls asking for advice but we do not know if students, and their parents, continue to have difficulties with their award applications please let us know the good news and the bad news. We can then help to



inform other students in this and future years.

Next month - we look at the implications for pupils in Year 9 who are about to choose their GCSE's to start this September.

In May - we will aim at those students just starting to think about applying for entry to University in 1998 and the

latest developments in I.T. Recruitment.

If you cannot wait until then or if you require any help concerned with career, educational or employment choice then please phone Richard Wiltshire or Melanie Allen on JHQ 2585/2838 or call in to see us at the Careers Centre now located in Windsor School.

SAFETY HAZARD

All personnel and their dependents are to be aware that Rollerskating, Rollerblading and Skateboarding are considered as a road safety hazard and are illegal on public roads according to German Law

Wanted

Rheindahlen Youth Football Club (RYFC) is looking for new recruits aged between 6 - 14 years old to play in its age group based teams. The club is based in JHQ Rheindahlen and competes in a local German League in properly supervised conditions. Training takes place regularly and the club will soon have its own premises.



If you are interested, ring WO2 McKenna on JHQ Mil 3006 for more details.

LANCÔME PARIS

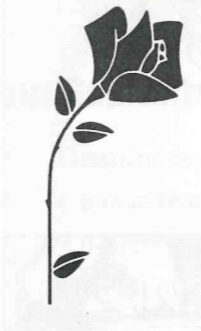

RASU PSI SHOP

LANCÔME PARIS



Wide selection of perfumes and cosmetics.
We stock all Sports Gear, Cherished Teddies,
Samsonite, Gifts and Jewellery.

SPECIAL OFFERS

* Buy 2 Ralph Lauren products and we give you a **T-shirt or backpack FREE**

* Childrens clothing - **half price**

* Ski clothes - **reduced**



Opening hours Monday - Friday 0900 - 1700, Saturday 0900 - 1300
RASU PSI Shop, 29 Granville Road, JHQ. Tel: JHQ Mil 4522, MG Civil 559617

RH1002P



Bombay Inn

Original Indian Restaurant

Only 5 km from JHQ

• Buffet every Thursday night •



New chef from Hotel Tai Mahal, India

- * We accept Abwicklungsscheine for parties of 4 or more. No discount available for buffet
- * Free Delivery Service
- * We'll open for you at lunchtime on request

Open daily from 17.00-23.00
Sundays 13.00-23.00

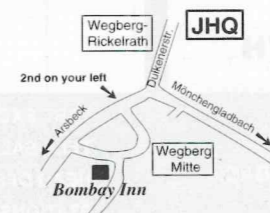

Fussbacher Str. 19
41844 Wegberg
Telephone 02434 - 6260

RH236P

NAAFI note book

JHQ Foodhall

Business as Usual!

Dear Customers

Due to refurbishment of the floor in the Foodhall, a temporary, but comprehensive, service will be established in a marquee on the front car park opposite the main JHQ NAAFI Complex.

There will be no change to opening hours.

The construction work does not affect Home & Leisure, Clothing or Financial Services Departments, where trade will continue as normal from the main building.

Our aim is to maintain an excellent standard of service,

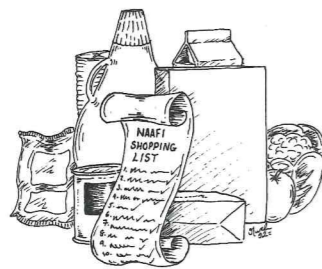

albeit in different circumstances throughout the construction period.

We apologise for any inconvenience to your normal shopping pattern.

Every effort will be made to ensure the work is completed as quickly as possible.

Dalmatiner Stuben



Balkan-Restaurant

OUR SPECIALITY STEAKS AND BALKAN FOOD

English menu-cards
Reasonable prices
Children's menu
Take away service
Payment by cheque possible
Party-room for 20-40 persons
14% saved through our party delivery service

OPEN DAILY
from 12 to 14.30 hrs
and 18 to 23.30 hrs.

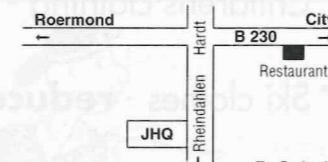

E. Soletic
41169 Mönchengladbach-Hardt
Vorsterstraße 321 - Tel. 02161/559344

NATOCARS at ELMPT

Your Guaranteed Local Service

- Genuine part exchange
- Choose from over 1000 models
- All prices discounted
- Special offers available
- Low rate finance and free credit protection
- Full no claims insurance
- Local delivery

Call in or phone
Jacque Sutherland today

Natocars Bruggen • Nachtigallenweg 2
41372 Niederkruchten • Elmpt
Telephone 02163 8618
Mobile 0172 531 2991
Fax 02163 83500



NATOCARS
A Rewarding Experience



MILITARY SURVEYORS RETURN TO BOSNIA

Seven members of Mönchengladbach-based 14 Independent Topographic Squadron Royal Engineers deployed to Bosnia in early January. They will form part of the twelve man Geographic Support Detachment at Headquarters Multi National Division (South West) in Banja Luka. They are replacing a mixture of Hermitage based 42 Survey Engineer Group and 14 Independent Topographic Squadron soldiers, who deployed to Bosnia in late June 1996.

Two members of the group, Corporal 'Daz' Bain and Sapper 'Scooby' McGregor, spent the first half of 1996 in Bosnia. At the time 14 Independent Topographic Squadron was deployed to Kiseljak in support of the ARRC led IFOR. A third soldier, Lance Corporal Bain, is returning to Bosnia for the third time. He spent the second half of 1995 providing field survey support to the UN forces, in what was then Sector South West - this included support to 19 Regiment Royal Artillery on Mount Igman. His more recent trip was for three months in the summer of 1996 assisting with the survey of the Inter-Entity Boundary Line.

Three of the remaining members of the group were among a group of four newly qualified Geographic Technicians who only joined the Squadron in October 1996. All four promptly volunteered for deployment

to Bosnia! Sappers 'Butch' Hicklin, 'Harry' Henderson and Stuart Cope were selected to deploy in January. The fourth will have to wait until June 1997 for his chance! The final soldier, Lance Corporal Dave Hill, has been waiting to deploy to Bosnia for the last four months. A winter in Canada last year prevented him from deploying with the rest of the Squadron, so he was subsequently nominated to deploy in September 1996. The reduction in size of the IFOR put a stop to this.

This deployment signifies 14 Independent Topographic Squadron's continued support to British Troops deployed in former Yugoslavia. The Squadron's involvement began in October 1992 with the deployment of a small section to HQ BRITFOR in Split and peaked between December 1995 and June 1996 with the deployment of the whole Squadron.

In Banja Luka the soldiers will be responsible for map supply to the headquarters and units under command, the operation of a mobile reprographic production system and the operation of TACISYS, a vehicle mounted computer system designed to assist in Terrain Analysis and Terrain Visualisation. The latter includes state of the art computer systems and has been developed based on experience gained by the deployment of prototype equipment during Op RESOLUTE.

1996 N & P REG CARS

" AT TAX FREE PRICES "

TOYOTA CARINA E	1.8GD	5 Dr	96 P	£ 10725
FORD ESCORT	1.5LX	5 Dr	96 N	£ 7800
FORD FIESTA	1.25LX	5 Dr	96 P	£ 7250
VAUXHALL ASTRA	1.4LS	5 Dr	96 N	£ 7450
FIAT BRAVA	1.4S	5 Dr	96 P	£ 7900

UK REGISTERED WITH BALANCE OF WARRANTY

ALSO RENAULT, VOLVO, PEUGEOT, VW/AUDI, HONDA ETC.

SPECIAL OFFERS

VOLVO	FREE DELIVERY & METALLIC
SAAB	FREE DELIVERY
VW/AUDI	SAVE UP TO £ 1000 ON AUDI A4
HONDA CIVIC 1.4i 5 Dr (elec pack)	£ 9995
SUBARU IMPREZA SPORT 4X4	£ 12000
NISSAN ALMERA FROM	£ 8500
MAZDA MX5 MX3 V6	SAVE £ 1000

WE WILL NOT BE BEATEN ON PRICE !!!

SUZUKI VITARA

SOFT TOP 1.6- 16V J LX SE, WITH ABS	£ 10495
D/AIRBAGS, ABS, P/STEERING, ELEC PACK,	
5 DOOR ESTATE 2.0T/D & V6-24V	£ 13295
D/AIRBAGS, AUTO (STD ON T/DIESEL), P/STEERING, ELEC PACK.	

ALSO AVAILABLE CHEROKEE JEEPS

PART EXCHANGE RHD & LHD - FINANCE AVAILABLE
TELE SALES OFFICE 02161 955588 / 551030
HEAD OFFICE
STATIONSPLEIN 5 6041 GN ROERMOND 0031 475 311067 EVENING

"Super offers every week"

- Tyres:** wide range of brands and sizes
 - Exhausts:** all models in stock
 - Brakes & Shock absorbers:** again all models - fitted by experts
 - Servicing:** balancing, tracking, tuning etc.
 - Aluminium Rims:** special offers on complete sets
 - Tax Free:** via your mess / PSI/PRI
- English spoken



How to find us

OPENING TIMES:
8.30 - 17.30
/ Sat 8.30 - 13.00
Only 5 minutes drive from JHQ

41844 Wegberg-Klinkum
Alte Landstrasse 293
Tel: 02434-4634

We also provide PRE-BFG READY service and all types of welding undertaken.
Your friendly dealer see you soon.
Book your appointment now!

FOR ALL THE LATEST INFORMATION
ON THE VOLVO RANGE OF CARS CONTACT
YOUR LOCAL VOLVO SPECIALIST
SM VIKING
BRÜGGEN / LAARBRUCH 02163 83044
JHQ 02161 550151



SM VIKING

YOUR FRIENDLY DEALER...JUST AROUND THE CORNER

VOLVO
Military Sales

FH4272p

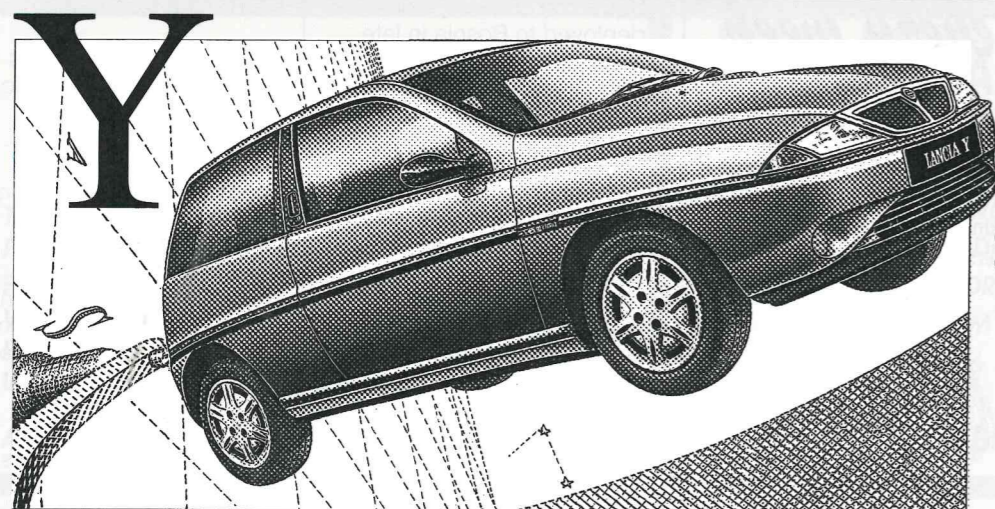

Lancia Y LE

FH1040p

Save 27%*
on all new
FIAT and
LANCIA cars

• We will provide you with expert advice and outstanding service!

For more information please call:
Mr. R. Nowack on (02452) 968121.

We are open 8.30 to 20.00 weekdays
and 9.00 to 16.00 on Saturdays.

Take the Dremmen exit from the A46.

* Offer applies to all NATO military personnel and NATO civilians.

AUTO-CONEN GmbH
Erkelenzer Str 80-82
52525 Heinsberg

FIAT

LANCIA

ROAD
test

Rover MGF 1.8i VVC

Launched in late 1995, the MGF represents Rover's first attempt in twelve years to design and manufacture their own car without help from an outside manufacturer and is, forgetting Metros, Maestros and Montegos (and that is easy to do!), the first "real" new MG to be launched in over thirty years. It also represents Rover's attempt to tackle the burgeoning affordable sports car market. Thankfully for a relatively small manufacturer, the MGF has already proved brilliantly successful, resulting in UK waiting lists of approximately six months and probably contributing to BMW's decision to buy the company. However, in BFG it is not necessary to wait until August/September for delivery of your MGF; instead 'phone Clive Hodgson, who organised my test drive (02161 550573) and he can arrange delivery straight away and in plenty of time for the summer!

The MGF comes in two versions with tax free prices starting at £14,070 for the 118 bhp model and £16,090 for the 143 bhp version I tested. The more powerful car seems to represent the "better buy", as it features ABS brakes and electronic power assisted steering as standard. These combined options would add £1051 to the basic model's price; and, in addition, the VVC also features better looking alloy wheels, half leather interior and probably better UK resale values. Clive also has a special offer on the MGF 1.8i VVC in Volcano Pearlscint paint (a reddish-orange) at £15,995 which includes delivery to Bremerhaven, continental headlights etc.

First impressions can be misleading. Getting into the car through the wide opening doors is easy and once in and seated, there is plenty of leg, head and elbow room. Unfortunately I found that finding a comfortable driving position was not so easy, as the steering wheel (with airbag) does not adjust up and down; and the seats seem to be set too high - it is more like sitting in a GTi, rather than a sports car. Despite having the seat fully back, my knees were bent up and touched the steering wheel. On the road this stops the "racing style" of arm twirling and means that the driver has to push-pull and feed the wheel through the hands. This is all very "driving schoolish" and whilst probably politically correct, a push-on driver might have problems dealing with oversteer.

The driving position is also spoilt by the gear stick's knob being too high and like the wheel, made of plastic, which is not appropriate in a sports car. The centre console extends to where the driver's knee would naturally be and prevents, unless the driver is double jointed, placing of the clutch foot onto the left foot rest. This means the left foot is kept under the clutch pedal. Smaller colleagues had less problems with the seating position. I was asked not to mention that the glovebox was broken, as the car had been rush-prepared for my test drive. Normally, I would have done as requested, but I quickly discovered one or two other faults with this particular car, including poorly fitting windows and roof which contributed to increased wind noise and air turbulence in the cabin. It was actually possible to see gaps between where the windows were supposed to fit to the roof and where the roof was supposed to fit to the car body. The bonnet release handle would not release. The right turn indicator would not self cancel. The driver's side speaker only played static. The clutch pedal was incorrectly set up - you had to push it in as normal with your leg/ankle and then push down with the end of your foot to engage first and reverse. Finally the driver's side door release handle felt as if it were about to break off. Within two miles of driving I have to admit to being very disappointed with the Fri/Mon type faults I had noticed and I did wonder if I would ever get Rover to lend me other cars for appraisal, if I were to insult their MGF. However, once underway, I actually began to enjoy the MGF and although I would have been angry if I had just bought the car, all the faults I noticed could easily be fixed under warranty and the car was, after all, rush prepared.



Inside the car does look good and the various plastics used seem sturdy, although perhaps more use of vinyls and leather would be appropriate in a sports car - leather is a £681.00 option. The cream coloured instrumentation dials are easy to read and also look attractive, whilst the various buttons and column stalks fall easily to hand and work well, with the exception of the electric window switches, which are situated behind the gear stick. The column stalks work logically, but are let down, by being made of cheap plastic.

On the road the MGF is fast thanks to its Rover designed 1796cc K-series engine. This features variable valve control to produce 143 bhp at 7000 rpm and 128 lb ft torque at 4500 rpm and means 0-60 is in about seven and a half seconds and that the car will top 132 mph. The gearbox is smooth to use and it is fun to keep the engine in the higher rev range for better performance. The brakes were excellent and despite all the performance, fuel consumption was reasonable and should be circa 30 plus mpg on average. The MGF has a mid-engine configuration and double wishbone suspension with Hydragas springs, which would suggest a very sports car specification. However, Rover have engineered the chassis to give perhaps less driver involvement than they could have. Again the car feels more fast-GTi than sports car and offers less driver "fun" when compared to, say, a Mazda MX5. This is not a criticism, as the MGF will initially understeer safely if you approach a corner too quickly and lifting off the throttle will correct the car's position on the road. However, given sufficient room, the MGF can also be made to oversteer and the car can be controlled on the throttle. This forgiving chassis and slightly higher ride when combined with the excellent Hydragas springed ride quality would make the MGF a better day to day proposition than the MX5. It really depends on what you want from a sports car.

The essence of the MGF is wind in the hair motoring and two catches release the roof and it is easy to lower whilst seated. There is a zip out rear plastic window which is a good idea, when in a number of years time the plastic might have cracked and need replacing. Driving with the roof down is very pleasant with not too much wind buffeting, even in February when I had the car. As previously mentioned, roof up driving was spoilt by the poor fitting windows and roof on this particular car, although I understand that this is not usually the case. Roof up, the ventilation system worked well, visibility out and behind was good, there are additional storage compartments between the seats and also behind, where the hood folds down. The boot is relatively large for a sports car and is practical and all of this bodes well for longer journeys.

To conclude, despite a very poor first impression, I actually came away pleased with the MGF. The car would be easy to live with on a day to day basis, offering useful accommodation, an easy to raise and lower hood, stylish looks, good performance and economy, including insurance costs (Peter Jones at Culpeck (02161 - 559655 quoted £620 for me, which is cheaper than a GTi). My only criticisms concerned the dealer preparation of this particular car (build quality and paint finish were good) and a poor seating position. As there is a whole industry dedicated to restoring older MGs which is now turning its attention to the MGF, it would be quite fun finding accessories and tweaks for the car - £150 would buy a smaller lower gearknob and smaller racing style steering wheel, in suede or leather, with a brace to allow the steering wheel to be removed F1 style (beats having a crooklock when you are posted back to UK).

Backstreet

MORE SAILING MALARKEY

This is the second part of a two part article on Adventurous Sail Training at Kiel. Part One was printed last month.

Have you ever wondered if you are man (or woman) enough to crew or skipper a yacht out of sight of land in all weathers for long periods? Or could you learn to be the key trained crewman on the foredeck teaching others how to change a sail with one hand whilst hanging on with the other? Do you fancy those magic moments of arriving at some small port on a rocky Scandinavian coastline at sunrise entering the harbour with only the Baltic fishing boats to keep you company? You can learn to sail and have the chance to do all this through the Adventurous Sail Training Centre Kiel.

Adventurous Training at sea with boats from the ASTC Kiel is no carefully guarded secret but a facility used by up to 2000 Service men and women each year, most of whom gain the internationally recognised Royal Yachting Association qualifications as RYA Crewmen or Skipper. How do you get your slice of Adventurous Training at Sea and qualify? Read on.

The German Baltic town of Kiel is home to the Adventurous Sail Training Centre (ASTC) which has a 'Training Fleet' of 10 Halberg Rassy 31 ft boats plus a classic 56 ft wood yacht 'Flamingo' and two 36 ft Rustlers for longer Adventurous Training Expeditions. These boats roam throughout the Baltic, the Gulf of Bothnia between Sweden and Finland and out through the Kattegat and Skagerrak to the North Sea on wide ranging expeditions.

Many of the crews are novices who have never sailed before. Each boat must, of course, have a correctly qualified skipper and one or two Competent Crew - the rest can be novices. There are training courses run at ASTC Kiel from April to October (see course list printed last month). The RYA Tidal and non tidal qualifications run something like this:

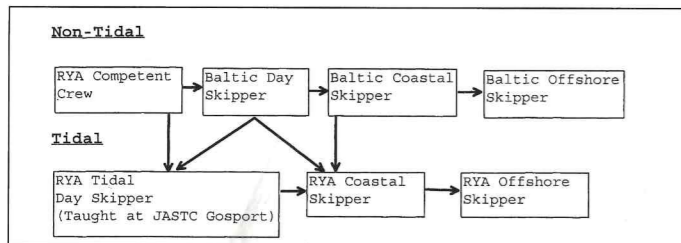

The RYA Tidal Day Skipper is not a Kiel course but is regularly run at the JSASTC Gosport in Hampshire.

Whilst earning your qualifications and training up your crew you will want to plan your expedition. Few of us can spare more than 10 days away but that need not necessarily prevent your boat from venturing further afield. Using a system of crew changes you could run, for example, a 3-leg expedition over a longer period involving more people.

To illustrate this point, I have made up an example of a 3 week expedition based on 3 crews which, if you wish, could all be from one unit:
Contact the Bulletin Editor on JHQ 3284 for a copy.

Remember with the former East Germany now open, there are cheaper ferry lines opening up across the Neuen Laender and Poland. Check with several travel agents locally for best prices.

Finally, as a soldier who has been involved in Adventurous Training for a good number of years, I am of the opinion that the ASTC Kiel is one of the finest training organisations of its sort. Always welcoming, ever flexible and accommodating, they have the access to one of the worlds best equipped



training fleets, and they want it to be fully used by you. Are you prepared to get yourselves organised? To quote the poet Rudyard Kipling:

If you can fill the unforgiving minute with 60 seconds worth of distance run,
Yours is the earth and everything that's in it,
And which is more you'll be a man my son.

Don't leave it all to someone else. Get your 60 seconds worth of distance run! Get your Atlas and diary out now and start planning.

Call the ASTC Charter Office on 0431 398833 or write to them at Box 2006 BFPO 105.

But then of course, you could just sit back and wish it would all come true - after all, what's 60 seconds? And who cares about green grass on the other side of the fence? Besides, they don't have SSV TV and videos on board these yachts.... or do they?

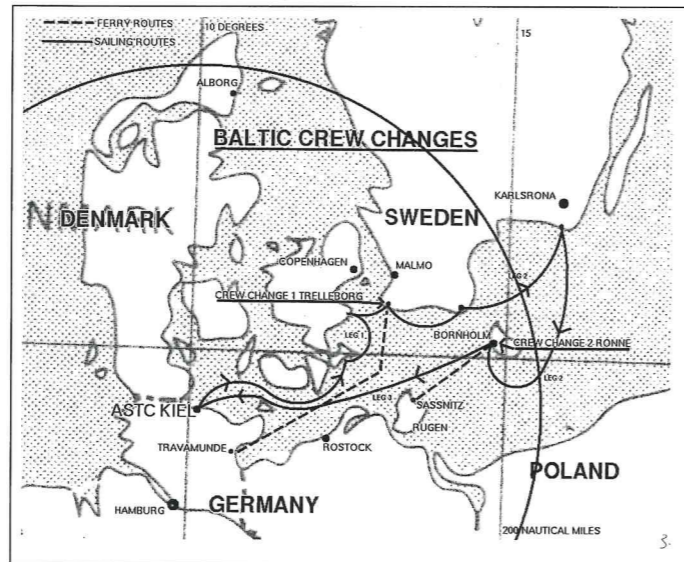

Windsurfing • Inline Skates • Canoes

Also used Surfboards available

van nieRop sport

Dr. Philipslaan 25 • NL Roermond • Tel. 0031 • 475 • 316 852
near Sijben Furniture

SHELL-Station KFZ-Meisterbetrieb

Heinrich Wilms
Hardter Str. 133
41179 Mönchengladbach
Tel.: 02161-580268

Opening times
Mo - Fr 6.30-20.00
Sa 6.30-18.00
Sun 9.00-18.00

Our Services are:



Maintenance Service

- New washing plant with 9 programmes (hot-wax, foam shampoo, underfloor)
- Inside cleaning
- Engine cleaning
- Underbody and hollow space protection
- Polish



Service/Oil change/Inspection

- Inspection of all cars
- Engine check
- Brake test
- Preparation for BFG



Tyre Service

- Assembly of all brand tyres and all sizes
- Balance
- Wheel tracking

•All works with guarantee•

All repairs more than DM 100,- TAX-FREE!
We accept coupons and credit cards

RH/004P

Voilà

FRENCH CAR WORKSHOP
A. GRZONKA -

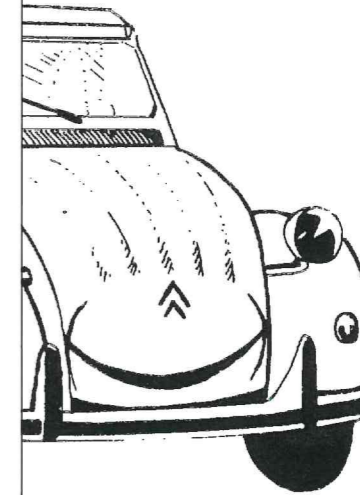

Your specialists in
CITROEN servicing
and repairs and all
other French, Japanese
and European Cars.
RENAULT, PEUGEOT, BMW
"VW, FORD, VAUXHALL,
MERCEDES.
Labour and parts at
extremely competitive
prices.

PREPARATION
FOR BFG ROAD TEST
QUOTATIONS
WITH NO OBLIGATION.

OPEN FROM

08.30 - 18.00 WEEKDAYS AND 09.00 -12.00 SATURDAYS
AM BAUMLEHRPFAD 9 - TEL. 02161 - 580387
41179 MÖNCHENGLADBACH - RHEINDAHLEN

RH/038P

SAAB
Military Sales

900S Convertible

9000 Anniversary

STOP PRESS!!
limited number
of autumn campaign
cars still
available!!!

Announce the launch of their 1997
SPRING CAMPAIGN
on show at:
JHQ MAIN NAAFI CAR PARK
from
Monday 3rd to Sunday 9th March (Inclusive)

For further information contact:
Chris Smith/Julie Kemp
Tel: 02161 - 556723
31 Wellington Road JHQ
(opposite Garrison Theatre)

* Part Exchange
* Test Drives
* Finance Arrangements

900S 5 Dr.

900S Coupe

RH/188P

VIDEO REVIEW

VAMPIRE IN BROOKLYN (15)

Starring: Eddie Murphy and Angela Bassett
Directed by: Wes Craven

From the Director of 'Nightmare on Elm Street' comes this rather peculiar film which didn't send shivers down my spine, but certainly left me cold.

Max, the vampire, arrives in America to find his 'mate'. To help him in his quest he recruits Julius and turns him into a zombie. Poor Julius deteriorates rapidly with bits of anatomy dropping off all over the place, but he's a loyal servant and doesn't bear a grudge. The 'mate' shows up in the form of Rita, a police officer investigating the series of strange and brutal murders plaguing Brooklyn. Unbeknown to Rita she's the daughter of a vampire and Max can't wait to get his hands, or rather teeth, on her. Enter her partner Justice (original name for a cop) knight in shining armour and saviour of the day. Eddie Murphy plays Max and a number of other roles, his trademark these days. We haven't seen him for so long I can only imagine he took the part for a bit of pre 'Nutty Professor' publicity, though seeing this is enough to put you off ever wanting to watch him again. The humour is sporadic and old hat, and if it's a fright you're after you'll not find it here - come back Christopher Lee - all is forgiven!

Star Rating **

THE TRUTH ABOUT CATS AND DOGS (15)

Starring: Uma Thurman and Janeane Garofalo
Directed by: Michael Lehmann

What we have here is two entirely different species trying to live together - forget the title, I mean men and women.

Dr. Abby Barnes hosts a veterinary radio show where listeners call in with their animal problems. She's successful, intellectual and eloquent but sees herself as rather plain and unattractive. She receives a call at work one day from a man called Brian, a photographer, who's having big problems with a dog he's borrowed from the pound for a commercial shoot. Abby not only talks Brian through the crisis but also talks him into keeping the dog and thus the story begins. Brian rings the station again to thank Abby for her help and to ask her out to dinner. Though dubious Abby likes the sound of his voice and agrees to meet him in the park. "Describe yourself", he says, "so I'll know who to look for." In a fit of madness Abby describes Noelle, her 5'10" blonde and beautiful neighbour and here's where her fun really starts. Determined to meet Brian, Abby cajoles her neighbour into taking her place and just tags along as a friend. Predictably, they both fall for Brian, so let battle commence and may the best woman win. Janeane Garofalo is very good as Abby, as is Uma Thurman

as Noelle. Ben Chaplin copes admirably as Brian, but I have to say that 'Hank' the dog, just about steals the show. It's as easy to watch, humorous film.

Star Rating ****

CUTTHROAT ISLAND (PG)

Starring: Geena Davis and Matthew Modine
Directed by: Renny Harlin

Initially I thought I was watching a truly awful film, until I put it into context - it's a swashbuckling adventure, no more and no less.

Morgan Freeman is your archetypal pirate, with just one slight difference - she's a woman. Her father dies leaving her a ship complete with motley crew and, of course, a map where 'X' marks the spot to the most bounteous treasure. Unfortunately though it's only a third of the original, her two uncles have the other pieces. Alas they aren't a close family and sharing the riches is not on the agenda at all. Morgan's map is in Latin and she partners up with an intellectual convict in the hope that he can translate it for her. Actually, he's an artful dodger in disguise and he manages to steal the other two pieces. She doesn't trust him one inch though but the bad guys are in hot pursuit and she really needs an ally. Sometimes it's just better the devil you know. Geena Davis is ill at ease playing Morgan Freeman, in fact it probably has to go down as one of the worst performances in the history of film. It's a tragedy really as all the ingredients are there - fabulous costumes, stunning locations and truly magnificent stunts, even the rest of the cast come up trumps. But, Ms Davis is barely off the screen and it's difficult to appreciate the films merits whilst constantly cringing at her.

However, it would be a great injustice to write the film off, it is, after all, entertaining. Watch it as you would a pantomime, just imagine Ms Davis as a rather overpowering 'Dame'.

Star Rating ***

Dawn Ingledew

All videos reviewed are available for hire from the English Video Club, JHQ. Telephone 551115.

The Rheindahlen Show



Bigger than ever, the Rheindahlen Show this year promises to be the social event of the BFG calendar. To be held within the Rheindahlen Military complex over the period 1-4 May 97 it will encompass the German Bank Holiday on 1 May 1997.

This year a major German Fair has been introduced to compliment the military displays and traders. Arena events will include the White Helmets Motorcycle Display Team, the RAF Falcons Parachute Display Team, the Band of the Hussars and Light Dragoons and the Pipes and Drums of the Queens Royal Hussars.

These displays will be supplemented by a programme of music from local bands, country dancing and martial arts. BFBS will be on hand to provide entertainment and broadcast live from the site. For those who yearn for a bit of excitement, the Terminator ride and the Bungee Jump will provide an interesting challenge. Numerous commercial organisations will display their goods and the primary furniture manufacturers will all be represented. NAAFI will host the first major Car Show of the year and there will be refreshment outlets to suit all tastes. Service and charitable organisations will provide informative displays and various cottage industry outlets will display a range of arts and crafts.

The Show has two principle aims; firstly to raise money for charitable and welfare organisations and secondly to provide an enjoyable day out for the family. With this in mind every effort has been made to ensure that the Show is a family affair offering something for everyone. The Show closes on 4 May with the drawing of the Shows Charity Draw, followed by the Beating of Retreat.

The Show is sure to provide a most enjoyable day out so make a date for your diary now, further information can be obtained from the Show co-ordination office on JHQ Ext 4765 or 4764.

beacon export

For the best Peugeot deal

We are your local Peugeot Export Approved Agents.

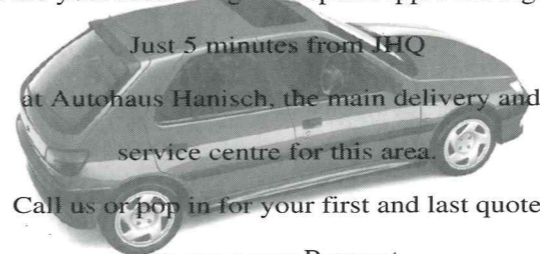

Special offers on all RHD Peugeots
Don't delay call your local office NOW

Peugeot main dealer back-up

Brian Walters and Tim Pope
Tel 02431-74976
Fax 72647
Weekdays 1000-1730
Saturdays 1000-1300
or call in at our showroom
AUTO HANISCH
Johannes Pellen Str. 16
41844 Wegberg

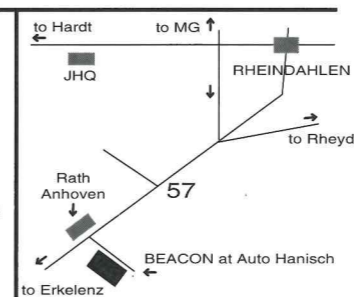

AUTOHAUS ENGELS... You're welcome



...has what you need.

We are a Total Quality Company - our aim is extraordinary Customer Satisfaction. We offer a highly skilled, fully trained team with twenty years experience!

Tax Free Sales for L.H.D. ROVER Cars MINI, MG and LAND ROVER products.

Excellent After Sales Service
 Accident Repairs

We are a selected car garage for all English insurance companies

Hire Car Service
 Original Warranty works
 English spoken

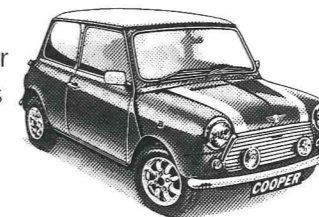

Your officially appointed Forces Specialist Service Dealer
Autohaus Herbert Engels
Kränkelsweg 35, 41748 Viersen
Visit or Phone us: 0 21 62 - 140 60

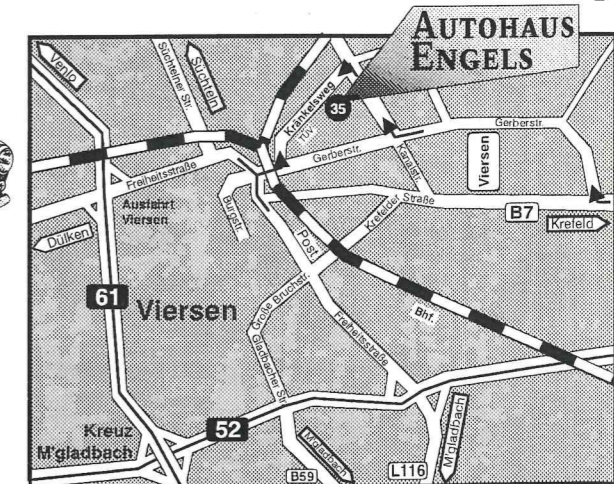
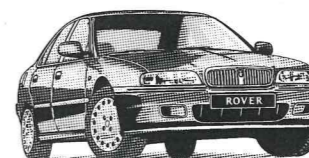

ENGLISH VIDEO CLUB

Tel. 55 11 15

RHEINDAHLEN
JHQ Shopping Complex

Over 2500 videos for RENTAL including all major NEW RELEASES

Wide variety of films FOR SALE orders also taken
MEMBERSHIP IS FREE
ALL WELCOME

RH/214

BORUSSIA

The month of January is traditionally taken up with indoor 5-a-side tournaments, culminating in the Hallen Meisters finals which this year took place in Munich. Borussia, who are not renowned for their expertise at the 5-a-side game, failed to qualify for the finals; a second place finish in Dusseldorf being the only result worth a mention.

As a result of the effort given over the first half of the season and during the Hallen Meisters tournament the team's 'punishment' was a two week jaunt in Portugal. The new management team have obviously fitted into the Borussia way of thinking very quickly.

During their time in the sun Borussia managed to fit in three 'friendly games with fellow German sides. The first game resulted in a 4-1 victory against fellow Bundesliga strugglers **MSV Duisburg**. As Duisburg had defeated Borussia in the last home game before the winter break perhaps new coach Bongartz had found some magic formula for success. The next two games, a 2-2 draw with **Fortuna Dusseldorf** followed by a 3-1 defeat by **Hertha Berlin** of the Zweite Liga soon put paid to that theory.

More important than the results of these games was the return from injury of **Ioan Lupescu** who has been greatly missed. His injury last September coincided with Borussia's dramatic loss of form.



Coach Bongartz is promising a new role for team leader **Stefan Effenberg** from the start of the Ruckrunde. He will hopefully be played in a sweeper type role similar to which has made Matthias Sammer 'Fussballer des Jahres'; however after the farce of the previous few months don't be surprised to see him in goal.

The fixtures for March are as follows, but check for late changes.

Sat 1 Mar Karlsruher SC (Away)

Sat 8 Mar Werder Bremen (Home)

Tue 11 Mar Hamburger SV (Away)

Sat 15 Mar 1.F.C.Köln (Home)

Sat 22 Mar Borussia Dortmund (Away)

Sat 29 Mar Fortuna Dusseldorf (Home)

David Maclachlan

MITSUBISHI MOTORS NAAFI CAR SHOWROOM JHQ

WE OFFER:

IMMEDIATE DELIVERY	YOUR NEW MITSUBISHI COMES WITH
PART EXCHANGE	3 YEAR LIMITED WARRANTY
FINANCE	3 YEAR EURO BREAKDOWN COVER
INSURANCE QUOTES	6 YEAR ANTI CORROSION
TEST DRIVES	FREE METALLIC PAINT
USED CARS	UK + CONTI LIGHTS
FRIENDLY ADVICE	FREE DELIVERY
	BLAUPUNKT STEREO

WE ARE LOCATED IN THE NAAFI SHOWROOM OPPOSITE THE GARRISON THEATRE

FOR MORE INFO OR A HOME APPOINTMENT CALL PAUL PORTER ON

**JHQ CAR SALES
02161-557789
Köln 0221-724630
Mobile 0171-5234004**

**STOP PRESS:
NEW GALANTS COMING SOON**

RH/009p

VOLVO TAX FREE SALES

YOUR SPECIALIST IN TAX FREE SALES FOR 20 YEARS

1. Right and lefthand drive for immediate delivery - worldwide specifications
2. Over 250 cars in stock
3. Huge selection of Mercedes in stock
4. Part exchange and Buy Back Guarantee LHD for RHD
5. Low cost no deposit finance in pounds sterling
6. 12 months warranty on used cars
7. Demonstration vehicles
8. Full after sales service in our own garage
9. Special models at special prices never advertised
10. Discover why thousands of people worldwide buy their new and used cars from us

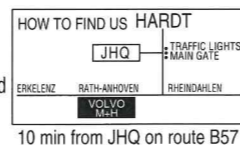

RH/253



**RING THE FREE PHONE HOT LINE
0130-859-469**

ASK FOR DAVE HORBAN
mühren Hoven International
Tax Free Sales • Tel: 02431-800927 • Fax: 800 930 • Service Workshop 800 921
Gladbacher Str. 41
4184 Wegberg
Germany

QUALITY - SAFETY - RELIABILITY ... AND THAT'S JUST THE DEALER!

RH/048p

OTTO GRUNERT

Cups, Trophies, Bronze Figures, Silver & Pewter Plates, Medals, Quick & Low Price Engravings

Schillerstraße 9 • 41844 Wegberg
Tel. 02434 / 4149 Fax 4692



OPENING HOURS
T - F 9 - 12.30
14 - 18.00
Sat 9 - 12.30

RH/048p

ELLEN CULPECK INSURANCE BROKER

ESTABLISHED FOR 30 YEARS

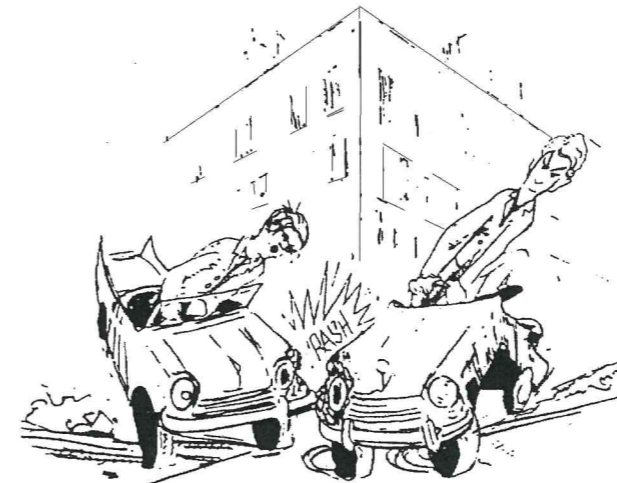

CAR INSURANCE

General Accident	USMIA
Norwich Union	Generali
Army Plan	Albingia
Euro-Risk	Guardian

* **The ONLY broker offering all of the listed Agencies.**

* **5 Star Accident Plan entitles you to a FREE courtesy car whilst yours is being repaired.**

* **Easy monthly payments.**

* **Low Cost Medical Insurance**

* **Huge discounts on certain insurance cover.**

ADAC

MEMBERSHIP & SCHUTZBRIEF
ETC. ON THE SPOT

SHOPPING CENTRE JHQ
41179 MÖNCHENGLADBACH/ RHEINDAHLEN
TELEPHONE 02161 / 559655
OFFICE HOURS: MONDAYS TO FRIDAYS
09.00 - 17.00 HOURS

RH/025p

Rheindahlen Tenpin Bowling Club



Firstly, I must apologise for not submitting any ramblings for the last few months. Still, hopefully, this will bring you all up to date.

Charity Presentation

During the past 12-18 months, Rheindahlen bowlers have raised a staggering DM10,587.08 for their chosen charity, St Piers School in Lingfield. The school caters for children with severe epilepsy and has been assisted by the bowlers for many years now.

The money was raised in several ways - a 24-hour marathon, a weekly jackpot and numerous raffles. Most of these projects were the brainchild of Mrs Jo Stevenson who has been the driving force behind the effort.

Our picture shows Jo shortly after the cheque was presented to Mr Bill Spragg, District Manager of NAAFI, without whose support the marathon bowl could not have been achieved.

Postal League

Many of you will be aware

that the RTBC now has a team entered in the RAF postal league. The team bowls on a Friday night and is usually "paced" by other members of the club. Lately, response has been so good that we now have teams of "wannabees" trying to get into the pacers and ultimately the "posties". These are turning out to be an excellent way to finish the week and the bowling of all has improved under the direction of the Club Captain, Geoff "Faron" Holme, so why not come along?

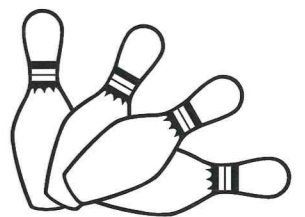

Ladies Tournament

The weekend 8/9 March sees a Ladies handicap tournament being held in the bowl. Entry details are on the noticeboard in the club. Why not enter, come along and assist the committee or just support our girls.

Signing off

Well, these are my last set of notes. An impending move dictates that I shall be standing down at the General Meeting on **27 February**. Thanks to all for the support I have received during my tenure and I trust my successor will gain the same. May you all bowl a 6

Bart

MAZDA TAX FREE

Exclusive agent for Mazda Cars (UK) Ltd.

ALAN ROUTLEDGE

Tel. 02163 898131
Mobile: 0172 6029158

Mazda has the complete range from small hatchback, family saloon, sports convertible to executive limousine

RH/301p

CINEMA programme

CINEMA SCHEDULE for THE GLOBE, RHEINDAHLEN

2, 7, 8 March	THAT THING YOU DO	(PG)
4, 6	CHAIN REACTION	(12)
8 Matinee	JAMES AND THE GIANT PEACH	(U)
9, 11, 13	THE MIRROR HAS TWO FACES	(15)
14, 15	FIRST WIVES CLUB	(PG)
15 Matinee	THE WIND IN THE WILLOWS	(U)
16, 21	STAR TREK: FIRST CONTACT	(12)
18, 20	MICHAEL COLLINS	(15)

22 March - 27 March, inclusive, cinema closed to install new projection equipment and Dolby Stereo Surround Sound.

28, 29	MATILDA	(PG)
29 Matinee	JACK	(PG)
30 Mar, 1 April	MATILDA	(PG)
3, 4, 5 April	101 DALMATIANS	(U)
5 Matinee	A GOOFY MOVIE	(U)

Rheidahlen Military Complex (RMC) Roadworks

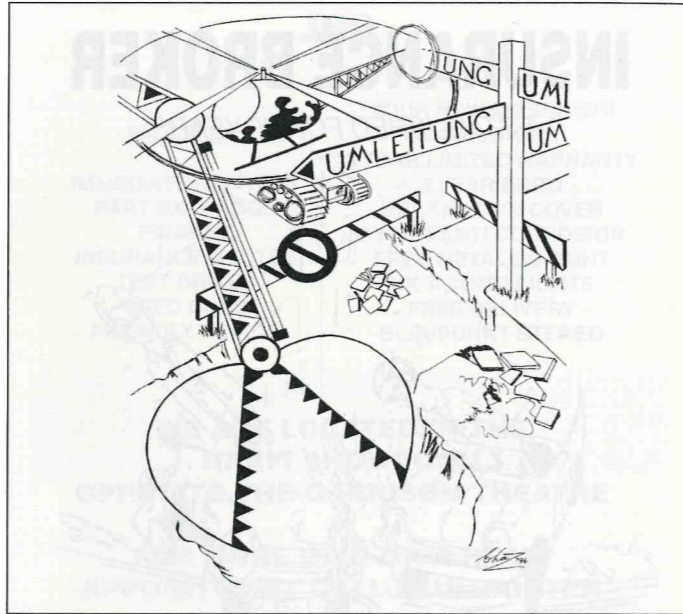

Extensive roadworks commencing in February 1997 will affect several areas of the RMC in the vicinity of the Town Centre and main NAAFI shop. The work will be in two phases and is scheduled to run until July. The streets to be resurfaced are:

Phase 1 (Feb to June)
Marlborough Road
Londonderry Drive
Pembroke Drive
Buckingham Way
Wrexham Walk
Oxford Walk

Phase 2 (Apr to Jul)
Vincent Road
Roberts Road
Hertford Walk
Aylesbury Way

Other streets affected by diversions will be:
Cumberland Drive
Dolgelly Walk

Exeter Way
Hereford Way
Lanark Walk
Portadown Way
Salisbury Walk
Sussex Drive
Gloucester Drive
Kinross Drive

Works will take place on one side of the road at a time but access to sites will be strictly limited to residents. Even so, access may be blocked for short periods and garages will become unavailable for use. Diversion routes will be signposted. Foot and cycle paths in Marlborough Road and Londonderry Drive will also be affected but again, one side at a time. A temporary bus stop for the Stadt MG service will be provided in Gordon Road

M J W Dean
Housing Officer

**WELKOM
WELCOME
WILLKOMMEN
BIENVENU**



Mr. and Mrs. Sleijster

in the P.M.C. JHQ Chazalroad

**We serve good coffee, snacks and meals.
Also large function room for hire.**

Telephone: 02161 - 47 Ext. 5307

Opening hours:
Mon - Thu 8.00 - 23.00 hrs
Friday 8.00 - 18.30 hrs
Saturdays available for bookings only

RH1001P

Your leading Authorised **MITSUBISHI** Dealer
Everything in one place:
Sales, Service, Leasing, Hire



Autohaus JACKELS

41844 Rath-Anhoven
Sales Grambuscher Str. 6
☎ 02431/4445 Telefax 02431/4154

Service: In Isengraben 57
☎ 02431/4973

MITSUBISHI MOTORS

RH1182

Rath-Anhoven

SMALL ADS

To be included, small ads must reach the Bulletin Office **with payment** by the 10th of the preceding month.
DM 10 for maximum of 20 words.
DM 20 for up to 30 words.

AEROBIC STEP AND LINE DANCING CLASSES

Held on Monday, Tuesday and Thursday evenings. Step Tuesday mornings.
Phone Phyllis 02434 24810.

ARTIST

Still-life classes held in JHQ. Also portraits painted. Restoration and cleaning of oil paintings. Contact Pamela Laird MG 551917.

AVB CLEANING

Married Quarter Cleaning Service. We specialise in worry-free march-outs.
Tel DUS 0211 432911.

BEAUTIFUL BOOKS

Host a book party - receive free books. Individual orders welcome. Demonstrators required. DK Family Library - Stephanie 02163 -81008.

ELEGANCE BALLGOWNS

Purchased in London for hire. No young children when viewing please. 15 minutes west of JHQ Erkelenz 02431 71322.

EYE ON DETAIL

Complete House Cleaning Service. March-outs guaranteed. We are just a phone call away 024 34 5777

EXCELLENT FIREWOOD

1 cbm (33 cm length split and cut) DM 94. 1 sack of kindling DM7. 1 cbm (25 cm length split and cut) DM 99. Delivery charge DM 10. Forester Matthias Jackels, Harbecker Strasse 68, 41844 Wegberg. Phone 02434-7106 and leave your telephone number.

MARKT GRILL

In Waldniel in the old historical market square: Excellent Greek 'Gyros'. Chicken, fish and chips. Tender pork Schnitzel. Spring rolls etc. Watch out for our weekly special offers. Open daily from 1130 to 2200 hrs. Sunday 1600 to 2100 hrs.
Tel. 02163-45484.

PARTY TIME!

Bored? Want to have some fun with friends? Book your Ann Summers party now! Contact Michelle 02161 556998

PIANO TUNING, SALE, HIRE OR REPAIR

Call Jan (Yan) Huijbers. Telephone and fax 0031 - 475 - 582622 (English spoken).

PICTURE FRAMING

For all your picture framing needs phone 02161-551676.

RHEINDAHLEN MOTOR CLUB

Tax free car spares (members discount). Servicing bays, tools and snow chains available to hire. New members welcome. Grenville Road (Opposite PRI Shop). Telephone MG 557409.

THE DIANE ASPINALL SCHOOL OF DANCING

New telephone number 02163 81534.

TONY'S DISCO SHOW

Music for all occasions. Telephone JHQ 2591 (Office) or Civ 02163 1845.

UNCLE MARMALADE

The children's magical entertainer who makes party troubles disappear. For fun at your party without worry, for children's parties the easier way, contact Mr Martin on MG 559413.

USCHI'S TOP TO TOE THERAPY

Qualified in chiropody reflexology, anti-stress massage and all beauty care. PRI Beauty Salon, JHQ. Telephone 02161-556139 or 955920.

WINDOWS "R" US

Window cleaning service. We are in your area on a regular basis. Marchouts our speciality. Contact Steve on 02161 87804.

WANT THAT JOB?

Let S&S Training write your CV. A professional service with a proven track record. Stand out from the crowd and get that interview. Phone/Fax 02163 32546 (after 18.00 hrs.) or Mobile 0172 6710452.

ZIGZAG DESIGNER KNITWEAR

New range of adults and childrens jumpers and cardigans direct from Scotland. Val Parsons 02161 - 558742.

CLUBS AND ACTIVITIES ON THE RMC

We need your help to update the list of Clubs and Activities held here on the RMC. Colonel Kirby, our new Commander, would like us to issue regular updates on the meetings held here in Rheidahlen. This we can only do with your help. If you run a club or a group of any type PLEASE, PLEASE inform us here at the Bulletin. You can ring, fax or write to us with the necessary information. Please also ensure that you keep us informed of any changes.

Telephone: 3284
Fax : 2106
Address: 3 Band Walk.

INDEX OF ADVERTISERS

Please tell our advertisers that you saw their advert in the **Rheidahlen Bulletin.**

ACCOMMODATION

'Margret' Privat Pension 45

EATING OUT

Balkanland Restaurant 24
Bombay Inn 33
China Garten 31
China Palast 25
China Town 19
Dalmatiner Stuben 34
El Pancho Mexican Restaurant 21
Hong Kong 27
India Palace 20
PMC Dutch Restaurant 44
Poseidon Greek Restaurant 20
Rani Indian Restaurant 29

FINANCE & INSURANCE

Culpeck Insurance Brokers 43

FURNITURE

Den Elzen 12
De Oude Spinde 9
Erwil Meubelen 8
Holland Furniture 4
Meubel Magazin Willems 4
Reulen Furniture 7
Roerstreek Meubelen 3
Sijben Wooncenter 1A
Star House Furnishings 3
The Suite Shop 11

GOODS & SERVICES

Adams (Pets, Darts) 22
Albertz (Electrical) 17

Ars Lignum 9
Body Care Beauty Salon 14
Call Back 16
Casabianca 8
Computer Club 15
English Video Club 14
Exotic Spice Shop 24
Figaro 14
Grunert, Otto (Trophies) 42
Kleeblatt Internet Services 22
Marianne's Salon 6
M&M Golfsport 17
Optic "Alte Post" 23
PMC Dutch Shop 2
PSI Shop 33
Telforce Communications 23
Uniformal 15
Van Nierop Sport 38
Vitus Centre (Shopping Mall) 14

HOLIDAY & TRAVEL

British Travel 28

MOTORING

Auto Conen 36
Auto Engels 41
Autohaus Jackels (Mitsubishi) 44
Auto Vennen (Ford) 41
Kars Direct 34
Mazda 43
Mitsubishi Cars 42
NATO-Cars 35
Peugeot Beacon Export 41
Reifen Rex (Tyres) 35
Rena Car Hire 45
SAAB JHQ 39
Shell Garage 39
SM Viking (Volvo) 36
Voila (Repairs) 39
Volvo Muhren & Hoven 42

RENA CAR RENTAL

- CARS AND VANS - ALL SIZES
- CHEAP RATES
- ACCIDENT / ADAC SERVICE
- ALSO OPEN WEEKENDS
- FREE DELIVERY AND COLLECTION

TEL.: 02161 - 582261
FAX: 02161 - 570188

Kothausen 7 a
41179
MÖNCHENGLADBACH
(5 minutes from JHQ)